

JVC

VIDEO CASSETTE RECORDER

HR-S5980AH
HR-S5980AJ

G-CODE™ / SHOWVIEW™
Hi-Fi SVHS
525/625
Super VHS ET

INSTRUCTIONS

LPT0800-001B

CONTENTS

SAFETY FIRST 1

Buttons, Connectors and Indicators 3

Basic Connections..... 4

Initial Settings 5

 Video Channel Set..... 5

 Auto Set Up..... 5

 Language Setting 6

 Clock setting..... 6

Playback 6

Recording..... 8

Timer Recording..... 10

 G-CODE™/SHOWVIEW™ System Setup 10

 G-CODE™/SHOWVIEW™ Timer Programming 10

 Express Timer Programming..... 11

 24H Express Timer Programming..... 12

 Automatic Satellite Program Recording..... 13

Program Navigation..... 14

 Navigation..... 14

Other functions..... 15

 Function Settings 15

Special Features..... 16

 Remote Control Functions 16

Tuner Setting 18

Editing 19

 Editing from a camcorder 19

 Edit to or from Another Video Recorder..... 20

 Audio Dubbing..... 20

System Connections 21

 Connecting/Using a Stereo System 21

Specifications..... 22

Information on Multi-System Compatibility..... 23

Troubleshooting 25

SAFETY FIRST

Safety Precautions

The rating plate and the safety caution are on the rear of the unit.
WARNING: DANGEROUS VOLTAGE INSIDE
WARNING: TO PREVENT FIRE OR SHOCK HAZARD, DO NOT EXPOSE THIS UNIT TO RAIN OR MOISTURE.

CAUTION

- When you are not using the recorder for a long period of time, it is recommended that you disconnect the power cord from the mains outlet.
- Dangerous voltage inside. Refer internal servicing to qualified service personnel. To prevent electric shock or fire hazard, remove the power cord from the mains outlet prior to connecting or disconnecting any signal lead or aerial.

ATTENTION

1. This recorder can also receive SECAM colour television signals for recording and playback.
2. Recordings made of SECAM television signals produce monochrome pictures if played back on another video recorder of SECAM standard, or do not produce normal colour pictures if played back on another video recorder of PAL standard.
3. SECAM prerecorded cassettes or recordings made with a SECAM video recorder produce monochrome pictures when played back with this recorder.

IMPORTANT

- Please read the various precautions on this page before installing or operating the recorder.
- It should be noted that it may be unlawful to re-record pre-recorded tapes, records, or discs without the consent of the owner of copyright in the sound or video recording, broadcast or cable programme and in any literary, dramatic, musical, or artistic work embodied therein.

Caution on Replaceable lithium battery

The battery used in this device may present a fire or chemical burn hazard if mistreated. Do not recharge, disassemble, heat above 100°C or incinerate.

Replace battery with Panasonic (Matsushita Electric), Sanyo, Sony or Maxell CR2025.

Danger of explosion or Risk of fire if the battery is incorrectly replaced.

- Dispose of used battery promptly.
- Keep away from children.
- Do not disassemble and do not dispose of in fire.

- Cassettes marked "S-VHS" and "VHS" can be used with this video cassette recorder. However, S-VHS recordings are possible only with cassettes marked "S-VHS". By using the S-VHS ET function, it is possible to record and play back with S-VHS picture quality on VHS cassettes with this recorder.
- HQ VHS is compatible with existing VHS equipment.
- G-CODE is a trademark of Gemstar Development Corporation and is registered in the following countries and areas: Australia, China, Hong Kong, Japan, South Korea, New Zealand, and Taiwan. SHOWVIEW is a trademark of Gemstar Development Corporation and is registered in the following countries: Austria, Belgium, Czech Republic, Denmark, Finland, France, Germany, Greece, Hungary, Iceland, Italy, Luxembourg, Netherlands, Norway, Poland, Portugal, Russia, Slovakia, South Africa, Spain, Sweden and Switzerland. The G-CODE/SHOWVIEW system is manufactured under license from Gemstar Development Corporation. G-CODE and SHOWVIEW are different trademarks used to represent the same easy recording feature. However, for simplicity, only the term G-CODE will be used in the instructions. If you use SHOWVIEW system, follow the same steps listed for the G-CODE system.

POWER SYSTEM

This set operates on voltage of AC110 V ~ 240 V~ (Rating), AC90 V ~ 260 V~ (Operating), 50 Hz/60 Hz with automatic switching.

The STANDBY/ON ϕ /I button does not completely shut off mains power from the unit, but switches operating current on and off. " ϕ " shows electrical power standby and "I" shows ON.

Video tapes recorded with this video recorder in the LP (Long Play) or EP (Extended Play) mode cannot be played back on a single-speed video recorder.

When the equipment is installed in a cabinet or a shelf, make sure that it has sufficient space on all sides to allow for ventilation (10 cm or more on both sides, on top and at the rear).

When discarding batteries, environmental problems must be considered and the local rules or laws governing the disposal of these batteries must be followed strictly.

Failure to heed the following precautions may result in damage to the recorder, remote control or video cassette.

1. **DO NOT** place the recorder ...
 - ... in an environment prone to extreme temperatures or humidity.
 - ... in direct sunlight.
 - ... in a dusty environment.
 - ... in an environment where strong magnetic fields are generated.
 - ... on a surface that is unstable or subject to vibration.
2. **DO NOT** block the recorder's ventilation openings or holes. (If the ventilation openings or holes are blocked by a newspaper or cloth, etc., the heat may not be able to get out.)
3. **DO NOT** place heavy objects on the recorder or remote control.
4. **DO NOT** place anything which might spill on top of the recorder or remote control. (If water or liquid is allowed to enter this equipment, fire or electric shock may be caused.)
5. **DO NOT** expose the apparatus to dripping or splashing.
6. **DO NOT** use this equipment in a bathroom or places with water. Also **DO NOT** place any containers filled with water or liquids (such as cosmetics or medicines, flower vases, potted plants, cups, etc.) on top of this unit.
7. **DO NOT** place any naked flame sources, such as lighted candles, on the apparatus.
8. **AVOID** violent shocks to the recorder during transport.

MOISTURE CONDENSATION

Moisture in the air will condense on the recorder when you move it from a cold place to a warm place, or under extremely humid conditions—just as water droplets form on the surface of a glass filled with cold liquid. Moisture condensation on the head drum will cause damage to the tape. In conditions where condensation may occur, keep the recorder turned on for a few hours to let the moisture dry.

ATTENTION TO MOBILE PHONE USERS:

Using a mobile phone in the vicinity of the recorder may cause picture vibration on the TV screen or change the screen to a blue back display.

ON PLACING THE RECORDER:

Some TVs or other appliances generate strong magnetic fields. **DO NOT** place such appliance on top of the recorder as it may cause picture disturbance.

Installing/removing the lithium battery

Be sure to connect the power plug to an AC outlet first before installing the lithium battery; otherwise, the battery's service life will be drastically shortened.

- 1 Make sure that the power plug is connected to an AC outlet and turn off the recorder power.
- 2 Open the battery cover while pressing the release tab as illustrated.
- 3 Insert a lithium battery with the plus (+) side up and push it in.
 - To remove the lithium battery, press the latch \otimes downward using a pointed non-metallic object, then pull out the lithium battery.
- 4 Close the battery cover until it clicks in place.

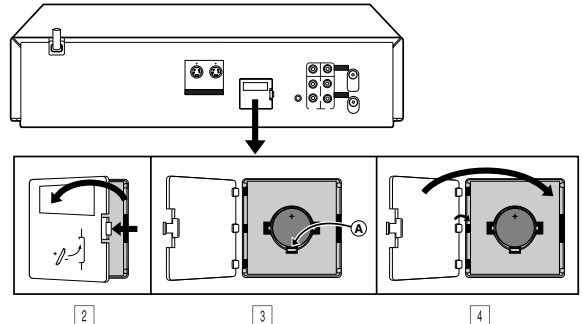

Video heads cleaning

The heads get dirty in the following cases:

- in an environment prone to extreme temperature or humidity
- in a dusty environment
- flaw, dirt or mold on video tapes
- continuous usage for a long time

Use a dry cleaning cassette — TCL-2 — when:

- Rough, poor picture appears while a tape is played back.
- The picture is unclear or no picture appears.
- "USE CLEANING CASSETTE" appears on the screen (only with "O.S.D." set to "ON" (Ⓞ 15)).

Usable cassettes

- Compact VHS camcorder recordings can be played on this video recorder. Simply place the recorded cassette into a VHS Cassette Adapter and it can be used just like any full-sized VHS cassette.
- This video recorder can record on regular VHS and Super VHS cassettes. While only VHS signals can be recorded on regular VHS cassettes*, both VHS and Super VHS signals can be recorded and played back using Super VHS cassettes.

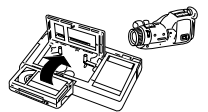

* By using the S-VHS ET function, it is possible to record and play back with S-VHS picture quality on VHS cassettes with this recorder (Ⓞ 16).

Buttons, Connectors and Indicators

Front Panel

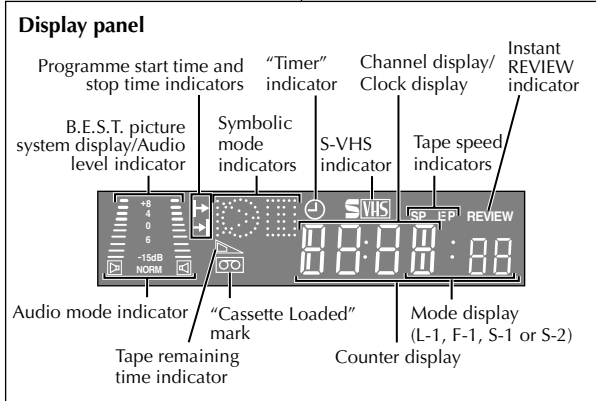
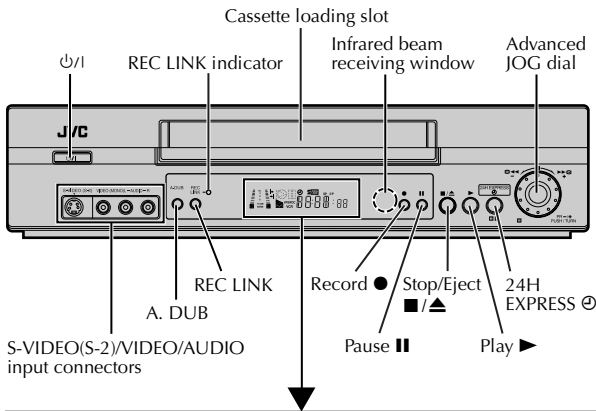

PLAY: FF/REW VARIABLE SHUTTLE SEARCH:		STILL:	
		SLOW:	
		RECORD:	
AUDIO DUBBING:		RECORD PAUSE:	
AUDIO DUBBING PAUSE:			

Rear Panel

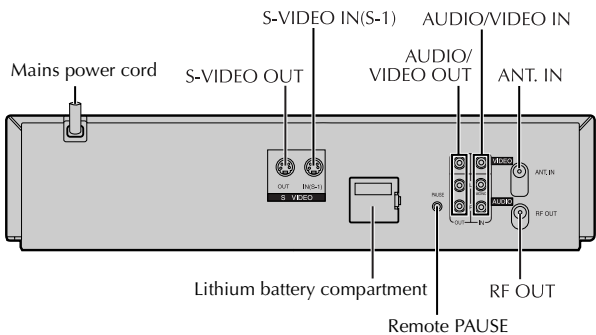

Remote control

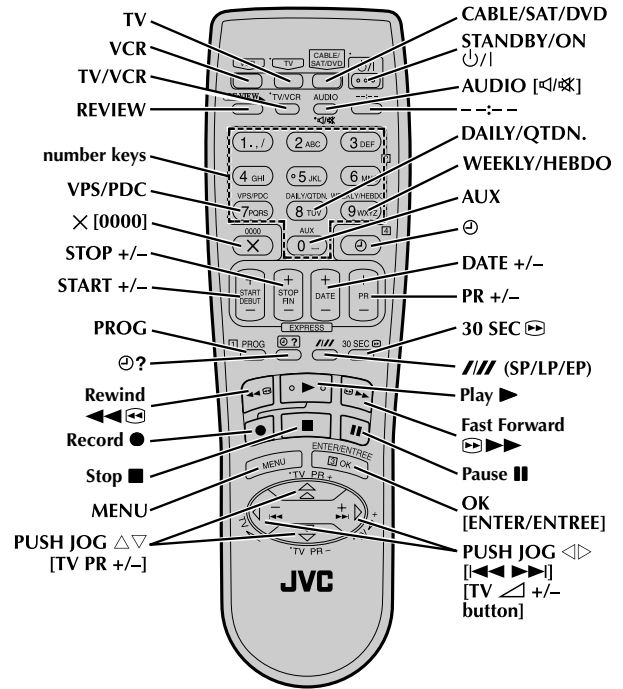

Buttons with a small dot on the left side of the name can also be used to operate your TV (Ⓞ 17).

On-screen display

If you press **ENTER (OK)** on the remote control when "O.S.D." is set to "ON" (Ⓞ 15), you can see the current recorder status on the screen. To clear the on-screen display, press **ENTER (OK)** again. The indications are not recorded even if the recorder is in the recording mode.

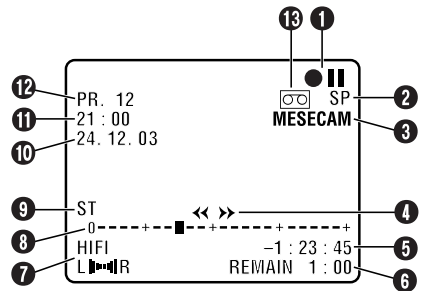

- 1 Operation mode indicators
- 2 Tape speed SP/LP/EP
- 3 Colour system indicator (Ⓞ 15)
- 4 Tape direction
- 5 Counter display
- 6 Tape remaining time indicator
- 7 Audio mode display (Ⓞ 8)
- 8 Tape position indicator (Ⓞ 8)
- 9 Type of broadcast (Ⓞ 9)
- 10 Current day/month/year
- 11 Clock display
- 12 Channel position number/Aux. indicator (L-1, F-1, S-1 or S-2)
- 13 Cassette loaded mark

Basic Connections

1 Check contents

Make sure the package contains all of the accessories listed in "Specifications" (☞ 22).

2 Situate recorder

Place the recorder on a stable, horizontal surface.

3 Connect recorder to TV

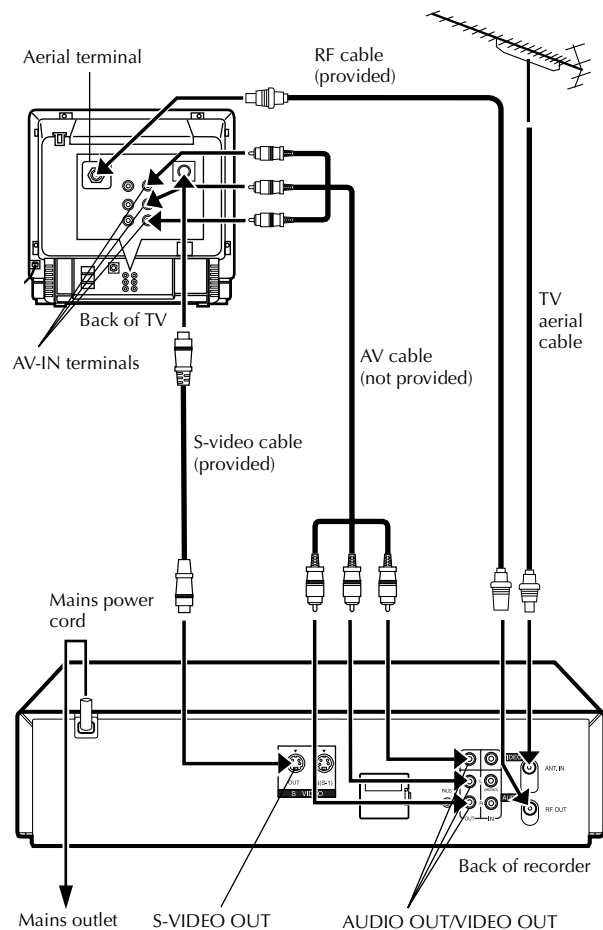

Connect the power plug to an AC outlet before installing the lithium battery. (☞ 2)

RF Connection

- 1 Disconnect the TV aerial cable from the TV.
- 2 Connect the TV aerial cable to the ANT. IN connector on the rear of the recorder.
- 3 Connect the provided RF cable between the RF OUT connector on the rear of the recorder and the TV's aerial connector.

AV Connection

If your TV is equipped with a AV Input Terminals connector, perform AV connection to improve picture quality during tape playback.

- 1 Connect the aerial, recorder and TV as shown in the illustration.
- 2 Connect an optional AV cable between the AUDIO OUT/VIDEO OUT connector on the rear of the recorder and the AV-IN terminals.

S-video Connection

(allows you to make the most of the S-VHS picture performance.)

If your TV is equipped with a S-video input connector

- 1 Perform "RF Connection" previously described.
 - 2 Connect the supplied S-video cable between the S-VIDEO OUT connector on the rear of the recorder and the S-video input connector on the TV.
 - 3 Connect an audio cable between the AUDIO OUT connectors on the rear of the recorder and the audio input connectors on the TV.
- Even if you are using audio/video cables to connect your recorder to your TV, you must also connect it using the RF cable. This will ensure that you can record one show while watching another.

4 Connect recorder to mains

Plug the mains power cord into a mains outlet.

Initial Settings

Video Channel Set

Video channel (RF output channel) is the channel on which your TV receives picture and sound signals from the recorder through the RF cable. Before performing the following steps, make sure the recorder's power is off and there is no cassette inserted in the recorder.

If you have connected the video recorder to your TV via the provided RF cable only (RF connection)...

1 Hold down **■/▲** on the recorder until the display panel shows the following.



2 Press **PR +** or **-** on the remote control to set appropriate TV system that matches the system of TV being used (refer to the table below).
1:B/G 2:D/K 3:I 4:H 5:M



Major Countries/Areas	TV System
New Zealand, Kuwait, U.A.E., Indonesia, Singapore, Thailand, Malaysia, Iran, Saudi Arabia, Egypt, Morocco, Lebanon, Iraq	B/G
China, Mongolia, Russia	D/K
Hong Kong	I
Australia	H
U.S.A., Japan, S.Korea, Taiwan	M

3 Set your TV to UHF channel 36.

• If the two vertical white bars appear clearly on the screen as shown on the right, press **OK** and then go to step 4.

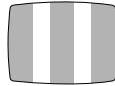

• If the two vertical white bars do not appear clearly, press **OK** and then **PR +** or **-** to set the recorder to a vacant channel between 28 and 60 which is not occupied by any local station in your area.

(Ex.) If channel 50 is available in your area...

Then set your TV to UHF channel 50 and check if the two vertical white bars appear clearly on the screen; if so, go to step 4. If not, re-set the recorder to another vacant channel and try again.

4 Press **OK** to finish video channel set.

If you have connected the video recorder to your TV via both the provided RF cable and an AV cable (AV connection) or via the provided RF cable, the provided S-Video cable and an Audio cable (S-VIDEO connection)...

1 Hold down **■/▲** on the recorder until the display panel shows the following.



2 Press **OK**, then press **PR -** until the display panel shows the following. Now the video channel is set to off (-).

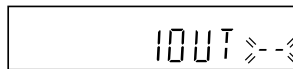

3 Press **OK** to finish video channel set.

• If Auto Set Up or Tuner Set has not previously been performed, the Language Select screen appears and Auto Set Up function takes place automatically.

Auto Set Up

The Auto Set Up function simplifies installation by guiding you through the procedures of setting the language, clock and tuner channels — simply follow the on-screen menus that appear.

Before starting, make sure of the following:

- The TV aerial cable should be connected to the recorder.
- The recorder's mains power cord should be connected to a mains outlet. (☞ 4)
- The "Video Channel Set" procedure should be done first and the TV should be set to its AV mode (with AV or S-VIDEO connection (☞ 4)) or video channel (with RF connection (☞ 4)).

IMPORTANT

- Don't press any buttons on the recorder or remote that are not directly related to the step you are performing while Auto Set Up is in progress.
- If you perform Auto Set Up successfully during installation, there's no need to separately perform the Language Select, Clock Set or Channel Set procedures, but if adjustments become necessary they can be performed as follows:
 - To change the selected language (☞ 6)
 - To reset or adjust the time (☞ 6)
 - To add/delete channels manually (☞ 18)
 - To reset the tuner after moving to a different location (☞ 18)

1 Select language

Press **PUSH JOG Δ∇** to place the pointer next to your desired language (English or Chinese), then press **OK** or **PUSH JOG ▷**.

- The Clock Set screen appears.

2 Set time

Press **PUSH JOG Δ∇** to set the time, then press **OK** or **PUSH JOG ▷**.

- Press and hold either button to delay or advance the time by 30 minutes.

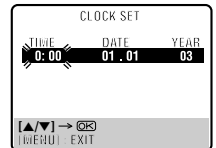

3 Set date

Press **PUSH JOG Δ∇** to set the date, then press **OK** or **PUSH JOG ▷**.

- Press and hold either button to change the date by 15 days.

4 Set year

Press **PUSH JOG Δ∇** to set the year, then press **MENU**.

5 Select TV system

Press **PUSH JOG Δ∇** to place the pointer next to the appropriate TV system (refer to the table on the left).

6 Start auto channel set

Press **OK** or **PUSH JOG ▷**.

- Receivable channels in your area are automatically assigned to the **PR +/-** buttons, and non-receivable channels are skipped.
- When Auto Set Up is completed, the lowest position number will appear on the front display panel. If "SCAN COMPLETED-NO SIGNAL-" is displayed on the screen, make sure that the aerial cable is connected to the recorder properly and press **OK** on the remote control. The recorder will try Auto Set Up again.

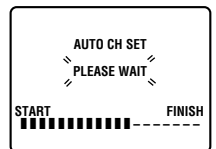

Language Setting

Turn on the TV and select the VIDEO channel (or AV mode).

You can change the language setting manually as required.

1 Access Main Menu screen, then Initial Set screen

Press **MENU** on the Remote. Press **PUSH JOG** Δ / ∇ to place the pointer next to "INITIAL SET", then press **OK** or **PUSH JOG** \triangleright .

2 Select language

Press **PUSH JOG** Δ / ∇ to place the pointer next to "LANGUAGE", then press **OK** or **PUSH JOG** \triangleright . Place the pointer next to the language of your choice (English or Chinese) by pressing **PUSH JOG** Δ / ∇ , then press **OK** or **PUSH JOG** \triangleright . Press **MENU** to return to normal screen.

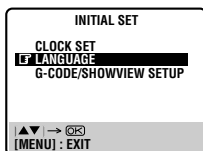
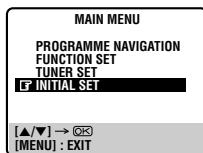

Clock setting

Turn on the TV and select the VIDEO channel or (AV mode).

1 Access Main Menu screen, then Initial Set screen

Press **MENU** on the Remote. Press **PUSH JOG** Δ / ∇ to place the pointer next to "INITIAL SET", then press **OK** or **PUSH JOG** \triangleright .

2 Access Clock Set screen

Press **PUSH JOG** Δ / ∇ to place the pointer next to "CLOCK SET", then press **OK** or **PUSH JOG** \triangleright . The Clock Set screen appears.

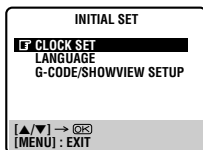
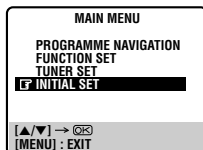

3 Set Time, Date and Year

Press **PUSH JOG** Δ / ∇ to set the time, date or year. Then press **OK** or **PUSH JOG** \triangleright .

- Press and hold either button to delay or advance the time by 30 minutes.
- Press and hold either button to change the date by 15 days.

Press **MENU** to return to normal screen.

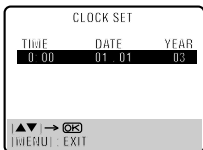

NOTE:

If the year digits are automatically cleared, it is possible that you have input February 29th in a non-leap year. Input the correct data.

To make corrections any time during the process

Press **OK** or **PUSH JOG** \triangleright repeatedly until the item you want to change blinks, then press **PUSH JOG** Δ / ∇ .

Playback

Basic Playback

Turn on the TV and select the video channel (or AV mode).

1 Load a cassette

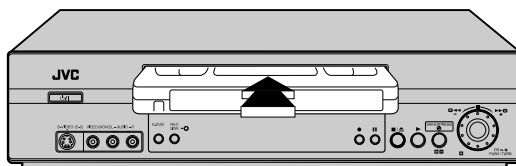

Make sure the window side is up, the rear label side is facing up and the arrow on the front of the cassette is pointing towards the recorder.

- Do not apply too much pressure when inserting.
- The recorder turns on, and the counter on the on-screen display is reset, automatically.
- Select the appropriate colour system with "PAL/MESECAM" and "NTSC" in Function settings (☞ 15).
- If the cassette's record safety tab has been removed, playback begins automatically (☞ 8).
- If the record safety tab is intact, the recorder check the tape information for Programme Navigation. For details, refer to "Navigation" (☞ 14).

2 Start playback

Press **▶**.

ATTENTION

In the search, still, slow-motion or frame-by-frame playback mode,

- the picture will be distorted.
- the noise bars will appear.
- there may be a loss of colour.

During playback

Stop playback

Press **■** on the remote OR Press **■**/**▲** on the recorder. control.

Pause playback and view still picture

Press **⏸**.

- Press **▶** to resume normal playback.

Pause and Frame-by-Frame playback

Press **⏸** to pause, then press **▶▶▶** (or **⏸**) repeatedly.

- Press **▶** to resume normal playback.

High speed search

Press **◀◀** or **▶▶**.

- Press **▶** to resume normal playback.
- If you press and hold **◀◀** or **▶▶** for more than 2 seconds, simply releasing it cancels the picture search, and normal playback resumes.

Picture search at variable speed (including slow-motion)

Press **PUSH JOG** \triangleleft or \triangleright repeatedly.

- Press **▶** to resume normal playback.
- Each time you press **PUSH JOG** \triangleleft or \triangleright , the playback speed changes. To decrease the speed during picture search, press the opposite direction button repeatedly.
- During still picture, press and hold **PUSH JOG** \triangleright to start forward slow motion playback. When you release the button, still picture resumes. During still picture, holding **⏸** for more than 2 seconds also starts forward slow motion playback. If you press **⏸** again, still picture resumes.

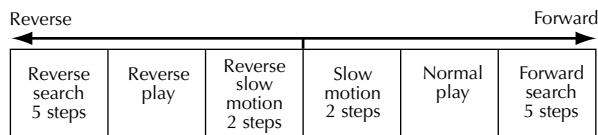
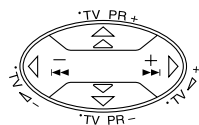

When the tape is not running

Rewind/fast-forward

Press ◀◀ or ▶▶.

Eject the tape

Press ■/▲.

- You can also eject the cassette when the recorder is turned off.

Turn off the recorder

Press ⏻/⏪.

Playback Features

Index search

Your recorder automatically marks index codes at the beginning of each recording. This function gives you quick access to any one of 9 index codes in either direction.



NOTE:

Before starting, make sure the recorder is in the Stop mode.

— Activate Index Search

Press **PUSH JOG** ◀ or ▶ (◀◀ or ▶▶) on the remote control. “◀◀ 1” or “▶▶ 1” is displayed on screen and search begins in the corresponding direction.

- To access index codes 2 through 9, press **PUSH JOG** ◀ or ▶ repeatedly until the correct index number is displayed.

Ex.: To locate the beginning of B from the current position, press **PUSH JOG** ◀ twice. To locate the beginning of D from the current position, press **PUSH JOG** ▶ once.

- When the specified index code is located, playback begins automatically.

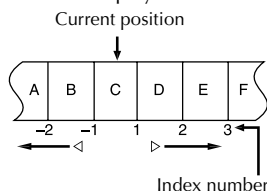

Manual tracking

Your video recorder is equipped with automatic tracking control. During playback, you can override this and adjust the tracking manually by pressing the **PR +/-** buttons.

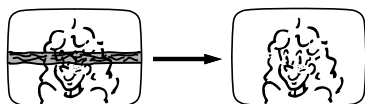

1 Override automatic tracking

Press **PR +/-** on the remote control to engage manual tracking.

2 Adjust tracking manually

Press **PR +/-** to adjust tracking.

- To return to automatic tracking, press **PR +/-** on the remote control.

NOTE:

When a new tape is inserted, the recorder enters the automatic tracking mode automatically.

Repeat playback

Your video recorder can automatically play back the whole tape 100 times repeatedly.



1 Start playback

Press ▶.

2 Activate repeat playback

Press ▶ and hold for over 5 seconds, then release.

- The Play indicator (▶) on the display panel blinks slowly.
- The tape plays 100 times automatically, and then stops.

3 Stop playback

- Press ■ at any time to stop playback.

NOTES:

- Pressing ▶, ◀◀, ▶▶ or || also stops Repeat Playback.
- Repeat Playback is not possible with a PAL tape recorded in EP mode.

Next function memory

The Next Function Memory “tells” the recorder what to do after rewinding. Before continuing, ensure that the recorder is in the Stop mode.

a- For Automatic Start Of Playback After Tape Rewind...

...press ◀◀, then press ▶ within 2 seconds.

b- For Automatic Power Off After Tape Rewind...

...press ◀◀, then press ⏻/⏪ within 2 seconds.

c- For Automatic Timer Standby After Tape Rewind...

...press ◀◀, then press ⏻/⏪ within 2 seconds.

NOTE:

It is not possible to select the Automatic Timer functions if the cassette's record safety tab is removed.

Tape position indicator

The tape position indicator appears on screen when, from the Stop mode, you press ▶▶, ◀◀ or perform an Index Search. The position of “■” in relation to “0” (beginning) or “+” (end) shows you where you are on the tape.

“O.S.D.” (⏻ 15) must be set to “ON”, or the indicator will not appear.

NOTE:

Depending on the type of tape used, there may be times when the indication is not correct.

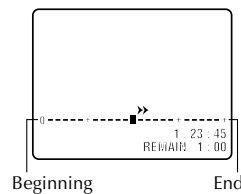

Skip search

— Skip over unwanted sections

Press **30 SEC 1** to 4 times during playback. Each press initiates a 30-second period of fast-motion playback. Normal playback resumes automatically.

NOTE:

Before return to normal playback during a Skip Search, press ▶.

Instant Review

Simply by pressing a single button, the recorder power comes on, rewinds, and begins playback of the last timer-recorded programme. If you have several programmes recorded, you can easily access any of them.

NOTE:

Before starting, make sure that the recorder is off and that the Timer mode is disengaged.

— Activate Instant Review

Press **REVIEW**. The recorder power comes on and the recorder searches for the index code indicating the start of the last timer-recorded programme. Once it's found, playback begins automatically.

- The front display panel tells you how many programmes have been recorded. If you have, for example, 3 programmes, "REVIEW" and "3" appear and blink. To watch the first of the 3 programmes, press **REVIEW** three times. The recorder searches and begins playback automatically. You can access a programme as far as 9 index codes away from the current tape position.

NOTE:

Instant Review is not possible while the recorder is in the Timer mode.

Soundtrack selection

Your video recorder is capable of recording three soundtracks (HI-FI L, HI-FI R and NORM) and will play back the one you select.

During Playback

Pressing **AUDIO** on the remote control changes the soundtrack being played back as follows:

Track		Use
Recorder's Front Panel	On-screen Display	
	HI FI L R	For Hi-Fi stereo tapes
	HI FI L	For main audio of Bilingual tapes
	HI FI R	For sub audio of Bilingual tapes
NORM	NORM	For audio-dubbed tapes
NORM	HI FI NORM	For audio-dubbed tapes

NOTES:

- "

Recording

Accidental erasure prevention

To prevent accidental recording on a recorded cassette, remove its safety tab. To record on it later, cover the hole with adhesive tape.



Record safety tab

Basic Recording

Turn on the TV and select the video channel (or AV mode).

1 Load a cassette

Insert a cassette with the record safety tab intact.

- The recorder power comes on automatically.
- The recorder checks the tape information for Programme Navigation. For details, refer to "Navigation" (14).
- Select the appropriate colour system (15).

2 Choose a programme

Press **PR +/-** or the **number keys**. Or push the **JOG** dial and turn it to the left or right to select the channel you wish to record.

3 Set tape speed

Press **///**. Check the SP/LP/EP indicator on the recorder display panel to confirm the selected tape speed.

4 Start recording

Press and hold and on the remote control, or press on the recorder.

- B.E.S.T. takes place at the beginning of each first SP and first LP (or EP) recording after inserting the cassette (15).

During recording

Pause recording

Press **II**.

- Press to resume recording.
- You can select channel in the recording pause mode.

Stop recording

Press on the remote **OR** Press / on the recorder control.

NOTE:

When recording in NTSC, if EP is selected, recording will always be done in the VHS mode even if an S-VHS cassette is used.

Recording Resume Function

If there is a power outage during recording (or Instant Timer Recording or timer recording), the recording will resume automatically when power is restored to the recorder unless the recorder's memory backup has expired.

Recording Features

Record one programme while watching another — Select channel to watch

Once recording is in progress, all you need to do is to set the channel controls on the TV for the station you wish to view.

- The programme selected with the TV's channel controls appears on the TV screen while the one selected with the **PR +/-** buttons is recorded on the tape.

Elapsed recording time indication

You can check the exact time of a recording.

1 Set counter display

Press **--:--** until a counter reading appears on the display panel.

- By pressing the **--:--** button, you can change the display to show the counter reading, channel position*, clock time or tape remaining time.

* Channel position is not displayed during playback.

2 Reset counter

Press **0000** before starting recording or playback.

- The counter is reset to "0:00:00" and shows the exact elapsed time as the tape runs.

Instant Timer Recording (ITR)

This easy method lets you record for from 30 minutes to 6 hours (selectable in 30-min. increments), and shuts the recorder off after recording is finished.

1 Start recording

Press **●** on the recorder.

2 Engage ITR mode

Press **●** again. "○" blinks and 0:30 appears on the front display panel.

3 Set recording duration

If you want to record for more than 30 minutes, press **●** to extend the time. Each press extends recording time by 30 minutes.

NOTE:

You can only perform ITR using the **●** button on the recorder's front panel.

Tape Remaining Time

— Display remaining time

Press **--:--** until the time remaining on the tape appears.

- The display panel shows the tape remaining time with "▢" displayed.
- By pressing the **--:--** button, you can change the display to show the counter reading, channel position*, clock time or tape remaining time.

* Channel position is not displayed during playback.

NOTE:

Depending on the type of tape used, there may be times when the tape remaining time reading may not appear right away, or is not correct. "--:--" may sometimes appear, or the display may blink on occasion.

Receiving stereo and bilingual programmes

Your recorder is equipped with a Sound-Multiplex decoder (A2) and a Digital stereo sound decoder (NICAM) as well, making reception of stereo and bilingual broadcasts possible.

When the channel is changed, the type of broadcast being received will be displayed on the TV screen for a few seconds.

Type of broadcast being received	On-screen display
A2 Stereo	ST
A2 Bilingual	BIL.
Regular Monaural	(none)
NICAM Stereo	ST NICAM
NICAM Bilingual	BIL. NICAM
NICAM Monaural	NICAM

- To listen to a stereo programme, press **AUDIO** until "☐" and "☐" appears on the front display panel or "HIFI L R" appears on the screen.
- To listen to a bilingual programme, press **AUDIO** until "☐" and "☐" appears on the front display panel, or "HIFI L R" or "HIFI L R" appears on the screen (as required).
- To listen to the Standard (regular monaural) audio while receiving a NICAM broadcast, press **AUDIO** until "NORM" appears on the front display panel or on the screen.

NOTE:

"O.S.D." must be set to "ON" or the on-screen displays will not appear (☞ 15).

To record stereo and bilingual programmes (A2)

- Stereo programmes are automatically recorded in stereo on the Hi-Fi audio track (with the normal audio track recording mixed L and R channel sound).
- Bilingual programmes are automatically recorded in bilingual on the Hi-Fi audio track. The main soundtrack will be recorded on the normal audio track.

To record NICAM stereo and bilingual programmes

The NICAM audio programme is recorded on the Hi-Fi audio track, and the standard audio programme on the normal audio track.

NOTES:

- If the quality of stereo sound being received is poor, the broadcast may be received in monaural with better quality.
- Before playing back a programme recorded in stereo, or a bilingual programme, refer to "Soundtrack selection" (☞ 8).

S-VHS (Super VHS), S-VHS ET or VHS Recording Mode

This VCR can record in S-VHS (Super VHS), S-VHS ET or VHS.

• To record in S-VHS:

Set "S-VHS MODE" to "ON" (☞ 16). Then, insert a cassette marked "S-VHS". The S-VHS indicator lights up on the display panel.

The S-VHS recording mode is selected.

• To record in S-VHS ET on a VHS cassette:

Set "S-VHS ET" to "ON" (☞ 16). Then, insert a cassette marked "VHS". The S-VHS indicator lights up on the display panel.

• To record in VHS:

Insert a cassette marked "VHS".

Set "S-VHS ET" to "OFF" (☞ 16).

• To record in VHS on a S-VHS cassette:

Insert a cassette marked "S-VHS". The S-VHS indicator lights up on the display panel. Then, set "S-VHS MODE" to "OFF" (☞ 16). The S-VHS indicator goes off.

The VHS recording mode is selected.

NOTE:

When playing back a tape that has been recorded in S-VHS or S-VHS ET, the S-VHS indicator lights up on the display panel regardless of the "S-VHS ET" (☞ 16) or "S-VHS MODE" (☞ 16) setting.

Timer Recording

Up to 8 timer recording programs can be made using G-CODE/SHOWVIEW timer programming or Express timer programming method as far as a year in advance. Remember, the clock must be set before you can program the timer.

NOTES:

- If all the 8 programs have already been set, "PROGRAM FULL" appears on the TV screen.
- After timer recording is completed, the recorder turns off automatically.
- You can program the timer recording while a regular recording is in progress; the menu screens will not be recorded.
- In case of a power failure after programming, the recorder's memory backup keeps your selections (if the lithium battery is not exhausted).

G-CODE™/SHOWVIEW™ System Setup

INFORMATION

G-CODE and SHOWVIEW are different trademarks used to represent the same easy recording feature, but only the term G-CODE system will be used in the instructions. If you use the SHOWVIEW system, follow the same instructions listed for the G-CODE system.

The G-CODE timer programming system eliminates the need to input channel, date, start and stop time data when setting the timer record function. Simply key in the G-CODE number for the TV programme you wish to record (found in most TV listings) and the recorder's timer is automatically programmed.

You have to set "GUIDE PROG" numbers, which are assigned to each station for purposes of G-CODE timer programming, for all the stations stored in your recorder's memory to get proper results.

Before G-CODE setup you must have performed the procedures of Tuner Set and Clock Set.

IMPORTANT

Perform the following procedure after Auto Set Up and/or the channel setting steps.

After setting the Guide Program Numbers, channel positions may be incorrect if you stored or skipped channels. In this case, re-perform Guide Program Number setting.

Guide Program Number Set

1 Access Main Menu screen, then Initial Set screen

Press **MENU** on the remote control. Press **PUSH JOG** $\Delta \nabla$ to place the pointer next to "INITIAL SET", then press **OK** or **PUSH JOG** \triangleright .

2 Access G-CODE/SHOWVIEW Setup screen

Press **PUSH JOG** $\Delta \nabla$ to place the pointer next to "G-CODE/SHOWVIEW SETUP", then press **OK** or **PUSH JOG** \triangleright .

3 Input Guide Prog number

Press **PUSH JOG** $\Delta \nabla$ or the **Number keys** to select the Guide Program number as shown in the TV listing, then press **OK** or **PUSH JOG** \triangleright .

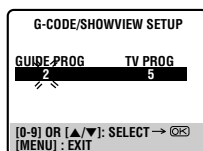

4 Input receiving channel number

Press **PUSH JOG** $\Delta \nabla$ or the **Number keys** to select the number of the channel on which the Guide Program number's broadcasts are received, then press **OK** or **PUSH JOG** \triangleright .

- If the satellite broadcast is received on your recorder's auxiliary channel ("L-1" or "F-1"), select "L-1" or "F-1" for the channel position to which the satellite receiver is connected.

- Repeat steps 3 and 4 as necessary.

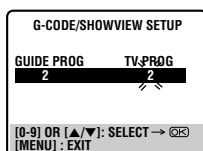

5 Return to normal screen

Press **MENU** on the remote control.

G-CODE™/SHOWVIEW™ Timer Programming

Before performing G-CODE/SHOWVIEW Timer Programming:

- Be sure to read "G-CODE™/SHOWVIEW™ System Setup" (☞ 10).
- Insert a cassette with the safety tab in place. The recorder will come on automatically.
- Turn on the TV and select the VIDEO channel (or AV mode).
- Select the appropriate colour system (☞ 15).

With the G-CODE system, timer programming is greatly simplified because each TV programme has a corresponding code number which your recorder is able to recognise.

1 Access G-CODE/SHOWVIEW NO. screen

Press **PROG**.

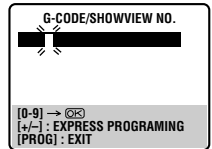

2 Enter G-CODE number

Press the **number keys** to enter the G-CODE number of a programme you wish to record.

- If you make a mistake, press **X** and input the correct number.

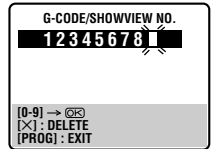

3 Enter G-CODE programme screen

Press **OK**, and the G-CODE Programme screen appears. (If you're just starting out, "P1" appears.)

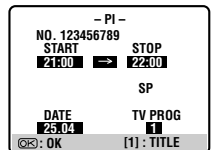

IMPORTANT

Make sure the channel position number you wish to record is displayed; if not, see "G-CODE™/SHOWVIEW™ System Setup" on page 10 and set the Guide Program number for that G-CODE number correctly.

- If the number you entered is invalid, "ERROR" appears on the screen. Press **X** and input a valid G-CODE number.
- If the "G-CODE/SHOWVIEW SETUP" screen appears, see "ATTENTION – Regarding Guide Program Number Set" on page 11.

4 Set tape speed

Press **///** to set the tape speed.

5 Access title edit screen

Press the **number keys** "1". The Title Edit screen appears.

- You can access the Title Edit screen only when "PROG. NAVIGATION" is set to "ON". (☞ 15)

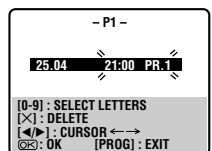

6 Enter programme title

Press the **number keys** and **PUSH JOG** \triangleright to enter characters, then press **OK**. For details, refer to "Entering Character" on page 14.

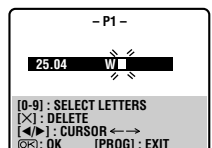

7 Return to normal screen

Press **PROG** or **OK**. "PROGRAM COMPLETED" appears on the screen for about 5 seconds, then normal screen appears. If "PROGRAM OVERLAPPED" appears on the screen and "Err" on the display panel, see page 13.

- Repeat steps 1 – 7 for each additional programme.

8 Engage recorder's timer mode

Press **⊙**. The recorder turns off automatically and "⊙" appears on the display panel.

- To disengage the timer, press **⊙** again.

Satellite Tuner Users

To timer-record a satellite broadcast using the G-CODE system:

- 1 Perform steps 1 – 8.
- 2 Set the satellite tuner to the appropriate channel before the selected programme begins.
- 3 Leave the satellite tuner's power on.

ATTENTION

Regarding Guide Program Number Set

“G-CODE/SHOWVIEW SETUP” appears after performing step 3 if the Guide Program number for the G-CODE number you entered has not been set.

- Press the **number keys** or **PUSH JOG** $\Delta \nabla$ to input the channel position number on which your recorder receives that station, then press **OK** or **PUSH JOG** \triangleright .

The G-CODE program screen appears.

(Ex.) To timer-record a RTR programme with the G-CODE system.

* If your recorder receives RTR on the channel position 2, press **OK** or **PUSH JOG** \triangleright after entering “2”.

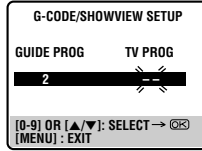

5 Enter programme date

Press **DATE**+/- . (The current date appears on screen. The date you enter appears in its place.)

6 Enter channel position

Press **PR** +/- .

7 Set tape speed

Press **///** to set the tape speed.



8 Access title edit screen

Press the **number keys** “1”. The Title Edit screen appears.

- You can access the Title Edit screen only when “PROG. NAVIGATION” is set to “ON”. (☞ 15)

9 Enter programme title

Press the **number keys** and **PUSH JOG** \triangleright to enter characters, then press **OK**. For details, refer to “Entering character” on page 14.

10 Return to normal screen

After confirming all information is correct, press **PROG** or **OK**. “PROGRAM COMPLETED” appears on the screen for about 5 seconds, then normal screen appears. If “PROGRAM OVERLAPPED” appears on the screen and “Err” on the display panel, see page 13.

- Repeat steps 1 – 10 for each additional programme.

11 Engage recorder's timer mode

Press \odot . The recorder turns off automatically and “ \odot ” appears on the display panel.

- To disengage the timer, press \odot again.

NOTES:

- To Timer-Record Weekly Or Daily Serials . . .
 . . . anytime during steps 2 through 10, press **WEEKLY** (number key “9”) for weekly serials or **DAILY** (number key “8”) for daily serials (Monday – Friday). Either “WEEKLY” or “DAILY” appears on the screen. Pressing the button again makes the corresponding indication disappear.
- You can programme this recorder to timer-record as many as 8 programmes. If you try to programme the recorder to record a ninth, “PROGRAM FULL” appears on screen and “FULL” appears on the front display panel. To record the extra programme, you must first cancel any unnecessary programmes (☞ 13).
- In case of a power failure after programming, the recorder's memory backup keeps your selections (if the lithium battery is not exhausted).

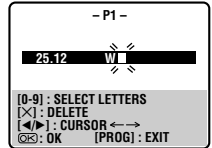
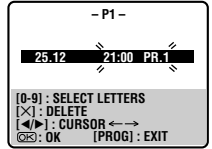

Express Timer Programming

Before performing the following steps:

- Insert a cassette with the safety tab in place. The recorder will come on automatically.
- Turn on the TV and select the VIDEO channel (or AV mode).
- Select the appropriate colour system (☞ 15).

1 Access G-CODE screen

Press **PROG**.

2 Access programme screen

Press **START** +/- . (If you're just starting out, “P1” appears.)

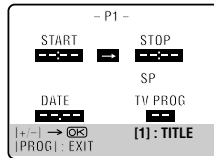

3 Enter programme start time

Press **START** +/- to enter the time you want recording to start.

- Press and hold **START** +/- to move in 30-minute increments, or press and release repeatedly to move 1 minute at a time.

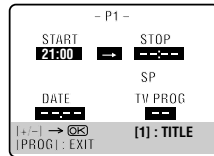

4 Enter programme stop time

Press **STOP**+/- to enter the time you want recording to stop.

- Press and hold **STOP**+/- to move in 30-minute increments, or press and release repeatedly to move 1 minute at a time.

24H Express Timer Programming

Before performing the following steps:

- Insert a cassette with the safety tab in place. The recorder will come on automatically.
- Select the appropriate colour system (ⓘ 15).

You can programme a timer recording that starts within 24 hours.

1 Access 24HR Express Timer Programme display

Push **24H EXPRESS** Ⓞ. “▶” and start time start blinking on the display panel.

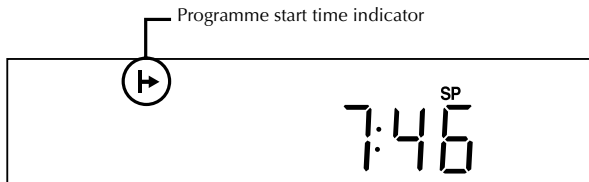

2 Set programme start time

Turn the **JOG** dial to the left or right. Then, push the **JOG** dial. “▶” and start time start blinking on the display panel.

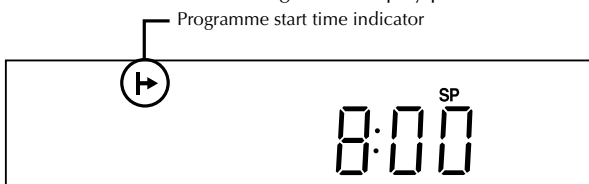

- One click stop of the **JOG** dial changes the time in 5-minute intervals.

3 Set programme stop time

Turn the **JOG** dial to the left or right. Then, push the **JOG** dial and channel number will start blinking.

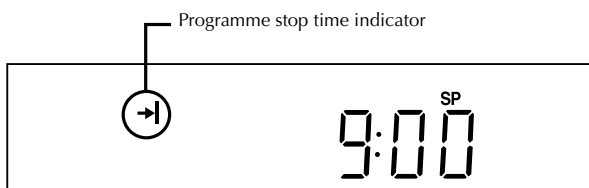

- One click stop of the **JOG** dial changes the time in 5-minute intervals.

4 Set channel position

Turn the **JOG** dial to the left or right. Then, push the **JOG** dial and channel number will start blinking.



- You can cancel the setting at any time by pressing and holding the **JOG** dial for more than 3 seconds. Repeat from the step 2.

5 Engage recorder's timer mode

Press **24H EXPRESS** Ⓞ.

The recorder turns off automatically and “Ⓞ” appears on the display panel.

NOTES:

- If “Err” appears on the display panel, repeat the steps again.
- When a menu screen is shown, you cannot use 24H Express Timer programming function. Press **MENU** to return to normal screen, and try again.
- You can use 24H Express Timer programming function also when the recorder is turned off.
- For 24H Express Timer programming function, the program overlap warning display does not appear even if some programs overlap each other.
- In case of a power failure after programming, the recorder's memory backup keeps your selections (if the lithium battery is not exhausted).

Check, cancel and replace programmes

1 Disengage timer mode

Press Ⓞ, then press Ⓞ/1.

2 Access Program Check screen

Press Ⓞ ?.

	START	STOP	CH	DATE
1	8:00	10:00	3	24.12
2	10:00	10:45	2	25.12
3	11:30	13:00	1	25.12
4				
5				
6				
7				
8				

Ⓞ? NEXT

3 Access Program screen

Press Ⓞ ? again to check more information. Each time you press Ⓞ ?, the next programme's information appears.

- P1 -	
START	STOP
8:00	10:00
SP	
DATE	TV PROG
24.12	3
[1]: TITLE	
Ⓞ? NEXT	

4 Cancel or replace a programme

Press X to cancel a programme.

To replace a programme, press the appropriate button: **START +/-**, **STOP +/-**, **DATE +/-**, **PR +/-**, **DAILY**, **WEEKLY** and/or **///**.

- If you do not want to edit the programme title, skip steps 5 and 6.

5 Access title edit screen

Press the **number key** “1”. The Title Edit screen appears.

- You can access the title edit screen only when “PROG. NAVIGATION” is set to “ON”. (ⓘ 15)

- P1 -	
24.12	3:00 PR.3
[0-9]: SELECT LETTERS	
[X]: DELETE	
[< >]: CURSOR ← →	
[OK]: OK	[PROG]: EXIT

6 Enter programme title

Press the **number keys** and **PUSH JOG** ▷ to enter characters, then press **OK**. For details, refer to “Entering character” on page 14.

- P1 -	
24.12	W
[0-9]: SELECT LETTERS	
[X]: DELETE	
[< >]: CURSOR ← →	
[OK]: OK	[PROG]: EXIT

7 Return to normal screen

Press Ⓞ ? as many times as necessary. If there are still some programmes remaining, go on to step 8.

8 Return to timer mode

Press Ⓞ.

When programme overlap each other

If "PROGRAM OVERLAPPED" appears, you have another programme overlapping the programme you have just made. The Programme Check screen appears and conflicting programmes will start blinking.

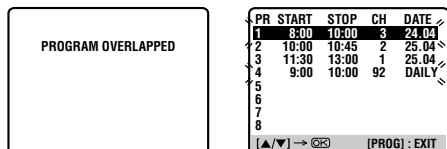

Example: Programme 1 (you have just made) and Programme 4 overlap each other.

1 Confirm the overlapping programmes

Overlapping programmes blink on the TV screen.

2 Select the programme to modify

Press **PUSH JOG** \triangle/∇ , then press **OK** or **PUSH JOG** \triangleright .

- You can only select one of the overlapping programmes.

NOTE:

If you do not mind this overlap, press **PROG** to finish the timer programme setting. The programme with the lower programme number will be recorded and the other one will not be recorded correctly. If no changes are made for approximately 1 minute, the recorder will return to the normal screen.

3 Cancel or change programme setting

To cancel a programme, press **X** when the Programme screen you do not want is shown. "PROGRAM COMPLETED" appears on the TV screen for about 5 seconds, then the normal screen appears.

To change a programme, press the appropriate button: **START +/-**, **STOP +/-**, **DATE +/-**, **PR +/-**, **DAILY**, **WEEKLY** and/or **///** when the Programme screen on which you want to make changes is shown, then press **OK**. "PROGRAM COMPLETED" appears on the TV screen for about 5 seconds, then the normal screen appears.

NOTE:

If the overlap is not yet solved, or another overlap occurs with the timer programme setting after making the last correction on a programme, the conflicting programmes will be shown on the Programme Check screen again. Repeat the above steps again until the overlap is solved.

Automatic Satellite Program Recording

This facility allows you to automatically record a satellite program which is timer-programmed on your external satellite receiver. Connect a satellite receiver to the recorder's rear AUDIO/VIDEO IN connectors and program the timer on the satellite receiver; the recorder starts recording when the signals input from the satellite receiver to the rear AUDIO/VIDEO IN connectors, and when there is no input signals the recorder stops recording and the power shuts off.

Before performing the following steps:

- Program the timer on the satellite receiver.
- Insert a cassette with the safety tab in place.

1 Set tape speed

Press **///** to set the tape speed.

2 Engage Auto Satellite Prog Rec mode

Press and hold **REC LINK** for about 2 seconds. The REC LINK indicator lights up and the recorder turns off automatically.

- To disengage the Auto Satellite Prog Rec mode, press **REC LINK**.
- If the recorder's power is off, it is not possible to engage the Auto Satellite Prog Rec mode.

ATTENTION

- Be sure not to turn on the satellite receiver before the program is executed; otherwise, the recorder will start recording when the satellite receiver's power is turned on.
- If you have connected another appliance other than a satellite receiver to the rear AUDIO/VIDEO IN connectors, be sure not to engage the Auto Satellite Prog Rec mode; otherwise, the recorder will start recording when the connected appliance's power is turned on.
- Auto Satellite Prog recording and timer-recording cannot be done at the same time.

NOTES:

- Auto Satellite Prog recording is only possible with the rear AUDIO/VIDEO IN connectors.
- When the Auto Satellite Prog Rec mode is engaged or the recorder's power is turned off after Auto Satellite Prog recording is finished, the recorder will not enter the Timer mode even though "AUTO TIMER" is set to "ON".
- For timer programming of the satellite receiver, refer to the instruction manual of the satellite receiver.
- Auto Satellite Prog recording is not possible if your satellite receiver does not have a timer.
- The REC LINK indicator blinks while Auto Satellite Prog recording is in progress.
- Pressing the recorder's ψ/π button while Auto Satellite Prog recording is in progress turns off and recorder's power and disengages the Auto Satellite Prog Rec mode.
- If there is more than one satellite program you wish to record with Auto Satellite Prog Recording, it is not possible to set a different tape speed for each; the tape speed selected in step 1 will apply to all the programs for Auto Satellite Prog recording.
- The B.E.S.T. (Ⓒ 15) does not work while Auto Satellite Prog recording is in progress.
- Depending on the type of satellite receiver, the recorder may not record a short portion at the beginning of the program or may record slightly longer than the actual length of the program.
- If you engage the Auto Satellite Prog Rec mode when the satellite receiver's power is on, the recorder will not start Auto Satellite Prog recording even though the button's light blinks. When the satellite receiver shuts off once and is turned back on again, the recorder starts recording.
- You can also record a program from your cable system in the same way if the system has a timer and is connected to the recorder's rear AUDIO/VIDEO IN connectors.
- When you press the recorder's **REC LINK** button to engage the Auto Satellite Prog Rec mode, if the REC LINK indicator does not light but instead blinks quickly even though your satellite receiver's power is off, Auto Satellite Prog Recording will not work properly with that satellite receiver*. If this is the case, perform "Express Timer Programming" (Ⓒ 11) to timer-record a satellite program.
* Some satellite receivers output signals even if the power is off. Auto Satellite Prog Recording is not possible with those satellite receivers.
- After Automatic Satellite Program Recording, the number of recorded programs will not be displayed on the front display panel for the instant Review function (Ⓒ 8).

Program Navigation

Navigation

Navigation Playback

Turn on the TV and select the VIDEO channel (or AV mode).

This function is useful when you wish to quickly find out what programmes you have recorded on a tape with this recorder. This function allows you to select a programme to watch, and then automatically searches for the start of the programme. (☞ 8)

1 Load a recorded cassette

Insert a cassette recorded on this recorder.

2 Access Main Menu screen

Press MENU.

3 Access Programme Navigation screen

Press PUSH JOG $\Delta \nabla$ to place the pointer next to "PROGRAMME NAVIGATION", then press OK or PUSH JOG \triangleright .

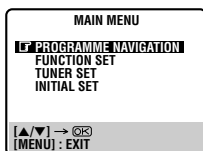

4 Select a programme

Press PUSH JOG $\Delta \nabla$ to place the pointer next to the programme you want to watch.

5 Start playback

Press OK. "SEARCHING" appears on the TV screen. Playback begins automatically after the selected programme is located.

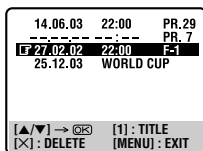

Programme Navigation Screen

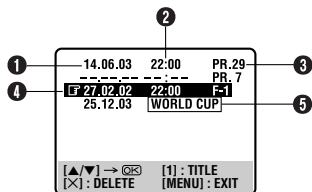

- 1 Recording date
- 2 Recording start time*
- 3 Station name*
 - * After entering the programme title (☞ 14), programme title appears instead of the recording start time and station name.
- 4 Currently selected programme
- 5 Programme title*
 - * Before entering the programme title (☞ 14), recording start time and station name appear instead of the programme title.

NOTES:

- You cannot edit programme title or delete tape data for the cassette with the record safety tab removed.
- Programme Navigation is possible with the cassettes recorded with this recorder only.
- Before recording, make sure the recorder's clock is set correctly.
- Program Navigation may not work properly depending on the tape being used.
- To record the programme information in this recorder's memory, you must continue to record each programme for over the minimum recording time;
 - PAL**
 - 8 minutes for the SP mode
 - 15 minutes for the LP mode
 - 23 minutes for the EP mode
 - NTSC**
 - 5 minutes for the SP mode
 - 15 minutes for the EP mode
- You can store programme information for up to 8 programmes on one cassette. At maximum informations for 10 tapes can be restored.
- The programme information is stored in this recorder's memory. If the memory in this recorder should ever be damaged and the programme information lost, it is impossible to restore that information.

Edit programme title

You can edit the the programme titles as you like.

Perform steps 1 to 3 of "Navigation Playback" on page 14 before continuing.

1 Select programme

Press PUSH JOG $\Delta \nabla$ to place the pointer next to the programme you want to edit.



2 Access title edit screen

Press the number key "1". The Title Edit screen appears.

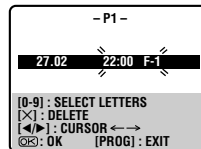

3 Enter programme title

Press the number keys and PUSH JOG \triangleright to enter characters, then press OK. For details, refer to "Entering character" on page 14.

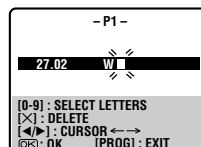

4 Return to normal screen

Press MENU.

Entering character

Press the appropriate number key, then press PUSH JOG \triangleright to enter each character. Refer to the example below.

NUMBER KEY	CHARACTER
1	., / - + * () 1
2	A B C 2 Ä Å Á Â Ã Ä Å Æ
3	D E F 3 È É Ê Ë
4	G H I 4 Ì Í Î Ï
5	J K L 5
6	M N O 6 Ö Õ Ö Ó Ô Õ Ñ
7	P Q R S 7
8	T U V 8 Û Ü Ú Û
9	W X Y Z 9
0	0 _

NOTES:

- If you make a mistake, press PUSH JOG $\triangleleft \triangleright$ to select the character, then enter the correct character.
- If you want to delete a character, press PUSH JOG $\triangleleft \triangleright$ to select the character, then press \times .

Delete tape data

Perform steps 1 to 3 of "Navigation Playback" on page 14 before continuing.

— Delete tape data

Press \times for more than 3 second. All the programme data on the tape are deleted, then normal screen appears.

- It is impossible to delete each programme information.

NOTE:

When you delete the tape data, only the tape information is deleted from the recorder's memory. The actual recording on the tape is not erased.



Other functions

Function Settings

You can use the other useful function settings on the Function Set screen

Turn on the TV and select the VIDEO channel (or AV mode).

1 Access Main Menu screen, then Function Set screen

Press **MENU** on the Remote. Press **PUSH JOG** $\Delta \nabla$ to place the pointer next to "FUNCTION SET", then press **OK** or **PUSH JOG** \triangleright .

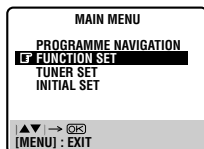

2 Select mode

Press **PUSH JOG** $\Delta \nabla$ to move the pointer to the function you want to set.

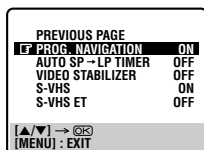
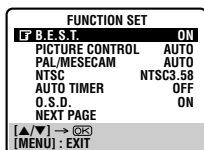

3 Change setting

Press **OK** or **PUSH JOG** \triangleright . The default setting is **bold** in the following table. Press **MENU** to return to normal screen.

■ B.E.S.T. — ON / OFF

When B.E.S.T. (Biconditional Equalised Signal Tracking) system is set to "ON", the recorder checks the condition of the tape in use during playback and recording, and compensates to provide the highest-possible pictures. When B.E.S.T. works, "bEst" appears blinking on the display panel. B.E.S.T. takes place whenever you play back a tape or start recording after inserting a cassette.

NOTE:

The recorder checks the tape condition for about 7 seconds, then starts recording. To make sure you record the desired scene or programme completely, perform the following steps:

- 1 Press and hold **●** and press **▶** on the remote, or press **●** on the recorder.
- 2 The recorder spends approximately 7 seconds assessing the condition of the tape, then begins recording.

■ PICTURE CONTROL — AUTO(NORM) / EDIT / SOFT / SHARP

This function helps you to adjust the playback picture quality according to your preference. *The default setting is "AUTO".

AUTO(NORM): Normally select "AUTO". It automatically adjusts the picture quality.

* When the B.E.S.T. function is set to "OFF" (☞ 15), you can only select "NORM" instead of "AUTO".

EDIT: Select when you dub tapes.

SOFT: Select when you want to soften the picture.

SHARP: Clearer, sharper-edged picture when viewing images with much flat, same-colored surfaces such as cartoons.

NOTES:

- When you select "EDIT" or "SOFT", the selected mode will not change until you select again "AUTO".
- When you select "EDIT" to dub tapes, be sure to select "AUTO" (or "NORM" when the B.E.S.T. function is set to "OFF") after you finish dubbing the tapes.

■ PAL/MESECAM — AUTO / PAL / MESECAM

Usually set to "AUTO" mode. The appropriate colour system (PAL/MESECAM) will be selected depending on the playback or recording signals.

If the "AUTO" mode does not work properly, select either of the following manual modes.

PAL: To record PAL signals, or playback a PAL tape.

MESECAM: To record SECAM signals, or playback a SECAM or MESECAM tape.

NOTES:

- SECAM signals will always be recorded as MESECAM. Select "AUTO" or "MESECAM" when recording SECAM signals.
- When playing back a SECAM tape, select "AUTO" or "MESECAM". The playback picture will always be monochrome.

■ NTSC — NTSC3.58 / NTSC4.43 / NTSC→PAL

This function is to record NTSC signals or playback a NTSC tape.

NTSC3.58: To record NTSC signals or playback a NTSC tape.

NTSC4.43: To record NTSC4.43 signals or playback a NTSC4.43 tape.

NTSC→PAL: To playback a NTSC tape on PAL TV.

NOTES:

- The "NTSC→PAL" mode does not work during recording. In this mode, NTSC signals will be recorded as NTSC3.58.
- The Menu screen is distorted during playing back a NTSC tape on PAL TV. Stop playback and access the Menu screen again.
- In the "NTSC4.43" mode, with some TVs, on-screen displays (Program screen, etc.) may roll up or down and there may be a loss of colour, when this happens, select the NTSC3.58" mode.

■ AUTO TIMER — ON / OFF

• When this function is set to "ON":

The timer recording standby mode is automatically engaged when the recorder is turned off. It is temporarily cancelled when the recorder is turned on. You do not have to press \odot to engage or disengage the timer recording standby mode.

• When this function is set to "OFF":

Press \odot to engage or disengage the timer recording standby mode.

NOTE:

"AUTO TIMER" does not work if "POWER SAVE" is set to "ON".

■ O.S.D. — ON / OFF

When this function is set to "ON", various recorder status information (on-screen display) appears on the screen.

NOTE:

When you use the recorder as the source player for editing a tape, be sure to set this function to "OFF". Otherwise, the recorder status information will be recorded on the edited tape.

■ PROG. NAVIGATION — ON / OFF

When you record a TV programme with this recorder, the recorder automatically stores in its memory the recording date, start time and station name. You can store these information for up to 8 programmes on one cassette. At maximum, information for 10 tapes can be stored. You can also enter the programme title when performing "G-CODE™/SHOWVIEW™ Timer Programming" (☞ 10) or "Express Timer Programming" (☞ 11). It is possible to store these information only when "PROG. NAVIGATION" is set to "ON" (default setting).

Set "PROG. NAVIGATION" to "OFF" if you don't want to record information on the programmes.

■ AUTO SP→LP TIMER — ON / OFF

When this function is set to "ON", the recorder automatically switches to LP mode to allow complete recording if there is not enough tape to record the entire programme while timer-recording in SP mode.

For example, recording a programme of 210 minutes in length onto a 180 minute tape.

Approximately 150 minutes Approximately 60 minutes

SP mode	LP mode
Total 210 minutes	

NOTES:

- If you have programmed the recorder to timer-record 2 or more programmes, do not use this function, but change the tape speed manually during timer programming.
- There may be some noise and sound disturbance where the tape speed switches from SP to LP mode on the tape.
- This function is not available during ITR (Instant Timer Recording), and will not work properly with any tapes longer than E-180 or with some tapes of shorter lengths.
- If you perform timer recording with both this function and VPS/PDC activated, and the programme goes beyond its originally scheduled length, sometimes the programme cannot be recorded in its entirety.

■ VIDEO STABILIZER — ON / OFF

When this function is set to "ON", you can automatically correct vertical vibrations in the picture when playing back unstable recordings made on another recorder.

NOTE:

To watch recordings with close-caption or when you finish viewing a tape, set this function to "OFF".

■ S-VHS — ON / OFF

You can determine which recording mode — either S-VHS mode or VHS mode — is used for recording on S-VHS tapes.

- **When this function is set to "ON"**, you can record on S-VHS tapes with S-VHS picture quality.
- **When this function is set to "OFF"**, you can record on S-VHS tapes with VHS picture quality.

NOTES:

- S-VHS mode allows you to make high quality video recordings with horizontal resolution of 400 lines, comparing with the 230 lines of resolution of conventional VHS recordings. To achieve the highest quality picture we recommended to record in S-VHS mode. (But remember that a conventional VHS recorder without SQPB cannot play back S-VHS tapes recorded in S-VHS mode.)
- S-VHS setting does not affect recording on VHS tapes. Recording on VHS tapes is always performed in VHS mode except when using S-VHS ET mode (☞ 16).

■ S-VHS ET — ON / OFF

When this function is set to "ON", you can record on VHS cassettes with S-VHS picture quality. Tapes recorded using this function can be played back on most S-VHS recorders or VHS recorders equipped with the S-VHS ET function or VHS recorder equipped with the SQPB (S-VHS QUASI PLAYBACK) function. When this function is set to "ON", the S-VHS indicator lights up on the display panel.

NOTES:

- Before recording, set "B.E.S.T." to "ON" (☞ see below).
- You cannot activate the S-VHS ET function while recording (☞ 8), timer-recording (☞ 10) or Instant Timer Recording (☞ 9) or the "B.E.S.T." function (☞ see below) is in progress.
- The S-VHS ET function does not work with S-VHS cassettes.
- To keep the highest quality recording and playback pictures over a long period of time, S-VHS recording on S-VHS cassettes is recommended.
- Use of high grade tapes is recommended for S-VHS ET recordings. On some tapes, picture quality will not improve even if the S-VHS ET function is used. Check the recording quality before you start important recordings.

Special Features

Remote Control Functions

Remote A/B Code Switching

The remote control is capable of controlling two JVC video recorders independently; one set to respond to the remote control's A code control signals and another set to respond to B code control signals. The remote control is preset to send A code signals because your video recorder is initially set to respond to A code signals. You can easily modify your video recorder to respond to B code signals.

1 Set remote control code for remote control

- 1 Press and hold **VCR**.
- 2 Press the **number key "2"**.
- 3 Press **OK**, and release **VCR**.

- The remote control now can transmit B code control signals.

2 Check remote control code for decoder

Press and hold **▶** on the recorder for more than 5 seconds while the recorder is turned off. The code currently set appears on the display panel.

3 Change code for recorder

Press any key on the remote control. The recorder now responds to B code control signals.

To control two recorders with the same remote control

You can control two JVC recorders by switching the remote control code for the remote control between A and B (☞ step 1), keeping two recorders to different control codes.

- To change only the remote control code for the remote control, DO NOT perform steps 2 and 3.

NOTE:

To set the recorder back to respond to A code signals, repeat the same procedure as shown above except pressing **number key "1"** instead of "2" in step 2 of 1.

Control Your TV Using Additional Buttons

Use the **number keys**, and the **///** button, **×** button or **⊖** button to select the TV's channel.

- With televisions under Code 01, 02, 07, 08, 10, 11, 14, 20, 22, 23, 24, 25, 27, 33, 35, 38, 40 or 42, the **///** button corresponds to the 1-digit/2-digit entry switching button (often labelled **- / -**) of your TV's remote control.
- With televisions under Code 01, 16, 28, 29, 34 or 39, the **×** button corresponds to the **10 +** button, and the **⊖** button corresponds to the **20 +** button of your TV's remote control.

NOTE:

The way these buttons are used is determined by your TV. Use these buttons as instructed for your TV's remote control.

TV Multi-brand Remote Control

Your remote control can operate the basic functions of your TV set. In addition to JVC TVs, other manufacturer's TVs can also be controlled.

1 Turn on TV

Turn on the TV using the Power button on the TV or its remote control.

2 Set TV brand code

- 1 Press and hold **TV**.
 - 2 Press the **number keys** to enter your unit's brand code.
 - 3 Press **OK**, and release **TV**. Check if the TV's power goes off as it should. If it does, try other operations (☞ step 2).
- Once you have set the remote control to operate the TV, you don't have to repeat this step until you replace your remote control's batteries.
 - Some TV brands have more than one code. If the TV does not function with one code, try entering another.

3 Operate TV

First, press **TV** to set the remote control to TV mode, then press one of the following buttons: $\psi/1$, **TV/VCR**, **TV PR +/-**, \triangle/MUTE (TV Muting), **TV** $\triangle/\text{+/-}$ (TV volume), and the **number keys**.

- For some brands, you must press **OK** after having pressed the **number keys** to enter a channel number.

IMPORTANT

Although the provided remote control unit is compatible with JVC televisions, as well as many other models, it may not work with your TV, or in some instances, may have limited function capability.

TV BRAND NAME	CODE	TV BRAND NAME	CODE
JVC	01, 23, 24, 25	mitsubishi	03
AIWA	36	MIVER	29
BEIJING	22	NEC	20
CCE	02	NOBLEX	22
CHANGHONG	34	NOKIA	31
DAEWOO	17, 37	PANASONIC	04, 11
FERGUSON	27	PEONY	34, 38, 39
FINLUX	30	PHILICO	10, 17, 21
FUNAI	32	PHILIPS	02, 42
GRADIENTE	15	SAMSUNG	12, 33, 34, 35
GRUNDIG	19	SANYO	13, 16
HITACHI	10	SHARP	06
ITT	28	SONY	07
JINXING	38	TCL	41
KONKA	40	THOMSON	26
LG/GOLDSTAR	18	TOSHIBA	08, 14

ATTENTION

The remote control can operate not only the video recorder but also some of your TV, cable box, satellite receiver and DVD.

- To operate your video recorder, first press the **VCR** button to set the remote control to the Video mode.
- To operate your TV, first press the **TV** button to set the remote control to the TV mode.
- To operate your satellite receiver, cable box or DVD, first press the **CABLE/SAT/DVD** to set the remote control to the satellite receiver, cable box or DVD mode.

Multi-brand Remote Control

For satellite receiver, cable box and DVD

Your remote control can operate the basic functions of your satellite receiver, cable box or DVD.

1 Turn on unit

Turn on the cable box, satellite receiver or DVD using the Power button on the unit or its remote control.

2 Set brand code

- 1 Press and hold **CABLE/SAT/DVD**.
 - 2 Press the **number keys** to enter your unit's brand code.
 - 3 Press **OK**, and release **CABLE/SAT/DVD**. Check if the unit's power goes off as it should. If it does, try other operations (☞ step 2).
- Once you have set the remote control to operate the unit, you don't have to repeat this step until you replace your remote control's batteries.
 - Some brands have more than one code. If the unit does not function with one code, try entering another.

3 Operate unit

First, press **CABLE/SAT/DVD** to set the remote control to cable box, satellite receiver or DVD mode, then press one of the following buttons:

For satellite receiver and cable box . . .

$\psi/1$, **TV PR +/-**, **number keys**.

For DVD. . .

$\psi/1$, \blacktriangleright , \blacksquare , **II**, $\blacktriangleright\blacktriangleright$, $\blacktriangleleft\blacktriangleleft$, \triangleleft ($\blacktriangleleft\blacktriangleleft\blacktriangleleft$) keys.

- For some brands, you must press **OK** after having pressed the **number keys** to enter a channel number.
- To change the unit's channels, press **TV PR +/-** or the **number keys**. (The **PR +/-** button can be used to change the recorder's channels only.)

IMPORTANT

Although the provided remote control unit is compatible with JVC satellite receiver and DVD, as well as many other models, it may not work with your unit, or in some instances, may have limited function capability.

Cable Box or Satellite Receiver Multi-brand Code

CABLE BOX BRAND NAME	CODE	CABLE BOX BRAND NAME	CODE
JVC	72, 73	KATHREIN	70, 71
AMSTRAD	60, 61, 62, 63, 92	LUXOR	68
BT	72	MASPRO	70
CANAL+	81	NOKIA	68, 87
CANAL SATELLITE	81	PACE	67, 86, 92
D-box	85	PANASONIC	13, 14, 74
ECHOSTAR	51, 78, 79, 80, 82	PFT	69
FINLUX	68	PHILIPS	66, 84
GALAXIS	69, 88	PHONOTREND	69
GRUNDIG	64, 65	SALORA	68
HIRSCHMANN	64	SKYMASTER	69
ITT	68	TPS	83
JERROLD	01, 04, 06, 11, 12, 15, 28, 75	VIDEOWAY	03, 09, 22, 76, 77
		WISI	64

DVD Multi-brand Code

DVD BRAND NAME	CODE
JVC	55
PANASONIC	58
PHILIPS	56
TOSHIBA	57

Tuner Setting

Turn on the TV and select the VIDEO channel (or AV mode).

IMPORTANT

Perform the following steps only if auto channel set has not been set correctly by Auto Set Up function (☞ 5) or if you have moved to a different area or if a new station starts broadcasting in your area.

Your recorder needs to memorise all necessary stations in channel positions in order to record TV programmes. Auto Channel Set automatically assigns all receivable stations in your area so that you can call them up with the **PR +/-** buttons without going through any vacant channels.

Auto Channel Set

1 Turn on the recorder

Press **⏻/⏮**.

2 Access Main Menu screen

Press **MENU**.

3 Access Tuner Set screen

Press **PUSH JOG Δ∇** to place the pointer next to "TUNER SET", then press **OK** or **PUSH JOG ▷**.

4 Select Auto CH Set mode

Press **PUSH JOG Δ∇** to place the pointer next to "AUTO CH SET", then press **OK** or **PUSH JOG ▷**.

5 Select TV system

Press **PUSH JOG Δ∇** to place the pointer next to the appropriate TV system, then press **OK** or **PUSH JOG ▷**.

- Auto Channel Set will start.

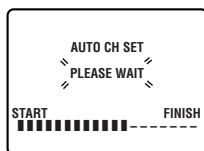
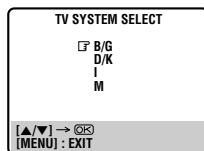
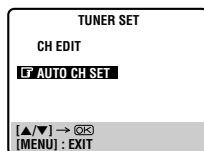
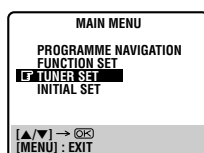

CH	FREQ	SYS	CH	FREQ	SYS
01	150	BG	07	229	BG
02	165	BG	08	237	BG
03	195	BG	09	355	BG
04	205	BG	10	365	BG
05	213	BG	11	374	BG
06	221	BG	12	384	BG

6 Return to normal screen

Press **MENU**.

NOTE:

If you perform Auto Channel Set when the aerial cable is not connected properly, "SCAN COMPLETED - NO SIGNAL-" appears on the screen in step 5. When this happens, make sure of the aerial connection and press **OK**; Auto Channel Set will take place again.

IMPORTANT

- If no sound accompanies the picture or the audio sounds unnatural on some channels that have been stored by Auto Channel Set, the TV system setting for those channels may be incorrect. Select the appropriate TV system for those channels. ☞ "TV System Selection — When you see the picture but the audio can't be heard or sounds unnatural" on page 19.
- Since your video recorder memorizes all detected stations even if the reception condition is poor, some of those stored stations may produce a noisy picture. To delete those stations, ☞ "Delete a Channel" on page 18.

Manual Channel Set

Store channels that were not stored during "Auto Set Up" (☞ 5) or "Auto Channel Set" (☞ 18).

1 Access Tuner Set screen

Perform steps 1 – 3 of "Auto Channel Set" on page 18.

2 Access Channel list

Press **PUSH JOG Δ∇** to place the pointer next to "CH EDIT", then press **OK** or **PUSH JOG ▷**.

3 Select position

Press **PUSH JOG Δ∇** to place the pointer next to an open channel position, then press **OK** or **PUSH JOG ▷**.

4 Select band

Press **PUSH JOG Δ∇** to place the pointer next to the band of your choice, then press **OK** to initiate Manual Channel Set.

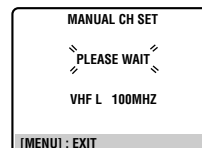
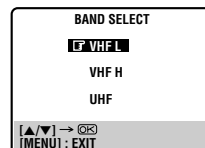

5 Set desired station

The screen to the right appears when a station is detected.

If you do not want to store the detected station...

Press **PUSH JOG Δ∇** to place the pointer next to "CONTINUE", then press **OK** or **PUSH JOG ▷**. Channel search will resume.

If you want to store the detected station...

Press **PUSH JOG Δ∇** to place the pointer next to "STORE", then press **OK** or **PUSH JOG ▷**. The Channel List appears again.

- The blueback screen and the TV picture currently being broadcast appear alternately for 8 seconds each.
- If you want to store another channel, repeat steps 3 – 5.
- When channel search completes for that band, the Band Select screen appears again. To set channels for other bands, select another band and start Manual Channel Set again (☞ step 4 and 5).



Delete a Channel

1 Access Tuner Set screen

Perform steps 1 – 3 of "Auto Channel Set" on page 18.

2 Access Channel list

Press **PUSH JOG Δ∇** to place the pointer next to "CH EDIT", then press **OK** or **PUSH JOG ▷**.

3 Select channel

Press **PUSH JOG Δ∇** until the channel you want to delete begins blinking.

CH	FREQ	SYS	CH	FREQ	SYS
01	150	BG	07	229	BG
02	165	BG	08	237	BG
03	195	BG	09	355	BG
04	205	BG	10	365	BG
05	213	BG	11	374	BG
06	221	BG	12	384	BG

4 Delete channel

Press **X**.

- To re-store it, simply press **PUSH JOG <**.
- Repeat steps 3 – 4 as necessary.

5 Return to normal screen

Press **MENU**.

CH	FREQ	SYS	CH	FREQ	SYS
01	150	BG	07	229	BG
02	165	BG	08	237	BG
03	195	BG	09	355	BG
04	205	BG	10	365	BG
05	213	BG	11	374	BG
06	221	BG	12	384	BG

Swap Channel Positions

Example: To swap CH03 and CH09.

1 Access Tuner Set screen

Perform steps 1 – 3 of "Auto Channel Set" on page 18.

2 Access Channel list

Press **PUSH JOG** Δ / ∇ to place the pointer next to "CH EDIT", then press **OK** or **PUSH JOG** \triangleright .

3 Select position (e.g. 03)

Press **PUSH JOG** Δ / ∇ until the section of CH "03" begins blinking, then press **OK** or **PUSH JOG** \triangleright .

- Only "03" will blink.

CH	FRQ	SYS	CH	FRQ	SYS
01	150	BG	07	229	BG
02	165	BG	08	237	BG
03	195	BG	09	355	BG
04	205	BG	10	365	BG
05	213	BG	11	374	BG
06	221	BG	12	384	BG

[0-9]: INPUT CH
[OK]: FINE TUNING
[MENU]: EXIT

4 Select position (e.g. 09)

Press number keys to input "0" and "9".

- The two selected channels will be swapped.
- To cancel the channel swapping, press **PUSH JOG** \triangleleft .

CH	FRQ	SYS	CH	FRQ	SYS
01	150	BG	07	229	BG
02	165	BG	08	237	BG
03	195	BG	09	355	BG
04	205	BG	10	365	BG
05	213	BG	11	374	BG
06	221	BG	12	384	BG

[4]: CANCEL
[OK]: OK
[MENU]: EXIT

5 Store new positions

Press **OK** or **PUSH JOG** \triangleright .

- Repeat steps 3 – 5 as necessary.

6 Return to normal screen

Press **MENU**.

Fine-Tuning Channels

1 Access Tuner Set screen

Perform steps 1 – 3 of "Auto Channel Set" on page 18.

2 Access Channel list

Press **PUSH JOG** Δ / ∇ to place the pointer next to "CH EDIT", then press **OK** or **PUSH JOG** \triangleright .

3 Select channel to fine-tune

Press **PUSH JOG** Δ / ∇ until the channel you want to tune begins blinking, then press **OK** twice.

- The "FRQ" number for that channel starts blinking.

CH	FRQ	SYS	CH	FRQ	SYS
01	150	BG	07	229	BG
02	165	BG	08	237	BG
03	195	BG	09	355	BG
04	205	BG	10	365	BG
05	213	BG	11	374	BG
06	221	BG	12	384	BG

[4]: FINE TUNING
[OK]: SELECT SYSTEM
[MENU]: EXIT

4 Perform tuning

Press **PUSH JOG** Δ / ∇ until the picture becomes clearer, then press **OK** or **PUSH JOG** \triangleright .

- Repeat steps 3 and 4 as necessary.

5 Return to normal screen

Press **MENU**.

TV System Selection — When you see the picture but the audio can't be heard or sounds unnatural

1 Access Tuner Set screen

Perform steps 1 – 3 of "Auto Channel Set" on page 18.

2 Access Channel list

Press **PUSH JOG** Δ / ∇ to place the pointer next to "CH EDIT", then press **OK** or **PUSH JOG** \triangleright .

3 Select channel

Press **PUSH JOG** Δ / ∇ until the channel you want to change its TV system begins blinking, then press **OK** three times.

- The "SYS" display for that channel starts blinking.

CH	FRQ	SYS	CH	FRQ	SYS
01	150	BG	07	229	BG
02	165	BG	08	237	BG
03	195	BG	09	355	BG
04	205	BG	10	365	BG
05	213	BG	11	374	BG
06	221	BG	12	384	BG

[4]: SELECT SYSTEM
[OK]: OK
[MENU]: EXIT

4 Select TV system

Press **PUSH JOG** Δ / ∇ to select the appropriate TV system (BG \rightarrow DK \rightarrow I \rightarrow M). Then press **OK** or **PUSH JOG** \triangleright .

- Repeat steps 3 and 4 as necessary.

5 Return to normal screen

Press **MENU**.

Editing

Editing from a camcorder

NOTES:

- All necessary cables can be obtained from your dealer.
- You can also use another video recorder as the player instead of a camcorder.
- When you select "EDIT" to dub tapes, be sure to select "AUTO" (or "NORM" when the B.E.S.T. function is set to "OFF") after you finish dubbing the tapes.

IMPORTANT

- To edit, both the player and the recorder must be of the same colour system. Select the appropriate colour system (15).
- PAL, SECAM and NTSC camcorders can be used as a player for editing.

A If the camcorder has no S-VIDEO output connector...

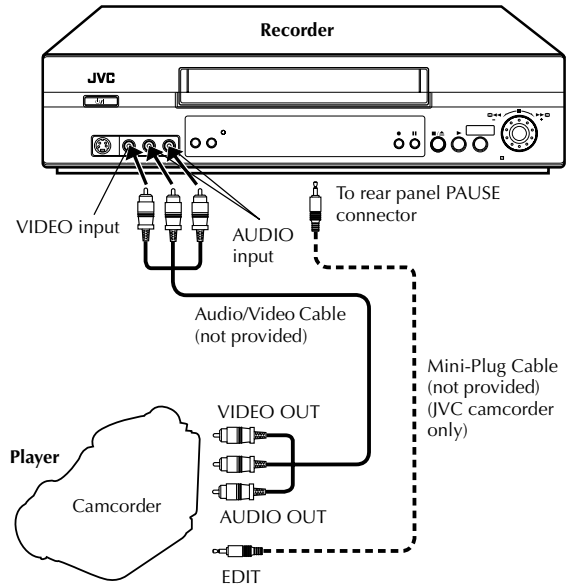

B If the camcorder has an S-VIDEO output connector...

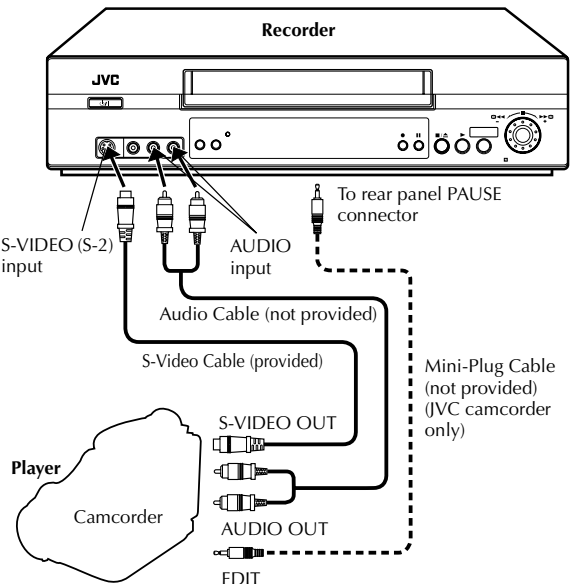

You can use a camcorder as the source player and your video recorder as the recorder.

1 Make connections

- A If the camcorder has no S-VIDEO output connector...
... connect the camcorder's AUDIO/VIDEO OUT connectors to the recorder's front panel AUDIO/VIDEO input connectors.
 - B If the camcorder has an S-VIDEO output connector...
... connect the camcorder's S-VIDEO OUT and AUDIO OUT connectors to the recorder's front panel S-VIDEO(S-2) and AUDIO input connectors. The recorder's rear panel S-VIDEO IN and AUDIO IN input connectors are also available.
- When using a monaural camcorder, connect its AUDIO OUT connector to the AUDIO L input connector on your recorder.
 - When a Master Edit Control-equipped JVC camcorder is used, the camcorder is capable of controlling the recorder. Refer to the camcorder's instruction manual for operating procedure.

2 Set recorder's input mode

Press number key "0" and/or PR +/- to select "F-1" for the AUDIO/VIDEO input connectors, or "S-2" for the AUDIO/S-VIDEO input connectors, depending on the connectors being used.

3 Select "EDIT" for picture control set mode

Follow the "Picture Control" section on page 15, then select "EDIT."

4 Start camcorder

Engage its Play mode.

5 Start recorder

Engage its Record mode.

You can use your video recorder as the source player or the recording deck.

1 Make connections

Connect the player's AUDIO/VIDEO OUT connector to the recorder's AUDIO/VIDEO IN connector.

- Use the L connector for monaural connection.

2 Set recording deck's input mode

Set to AUX. With this video recorder, press number key "0" and/or PR +/- to select depending on the connector being used — "L-1" for the rear panel VIDEO/AUDIO input connectors, or "F-1" for the front panel VIDEO/AUDIO input connectors.

3 Select "EDIT" for picture control set mode

Follow the "Picture Control" section on page 15, then select "EDIT."

4 Start source player

Engage its Play mode.

5 Set recording deck

Engage its Record mode.

NOTES:

- To edit, both the player and the recorder must be of the same colour system. Select the appropriate colour system (☞ 15).
 - When you use this recorder as the player for editing, be sure to set "O.S.D." to "OFF" before starting (☞ 15).
 - All necessary cables can be obtained from your dealer.
 - NTSC tapes being played back in the "NTSC→PAL" mode (☞ 16) cannot be dubbed to another recorder.
 - When you dub an NTSC tape using your recorder as the playback deck, select "NTSC 3.58" (or "NTSC 4.43") for "NTSC" setting (☞ 15).
 - When you select "EDIT" to dub tapes, be sure to select "AUTO" (or "NORM" when the B.E.S.T. function is set to "OFF") after you finish dubbing the tapes (☞ 15).
 - If you are using another recorder with S-Video and Audio input/output connectors, you can connect those connectors to this recorder's S-VIDEO IN/S VIDEO OUT and AUDIO IN/OUT connectors.
- When Using Your Video Recorder As The Source Player ...
... connect its rear panel S VIDEO OUT and AUDIO OUT connectors to the recording deck's S-Video and Audio input connectors.
- When Using Your Video Recorder As The Recording Deck ...
... connect its front panel S-VIDEO and AUDIO input connectors to the source player's S-Video and Audio output connectors. Then, set the recorder's input mode to "S-1".

Edit to or from Another Video Recorder

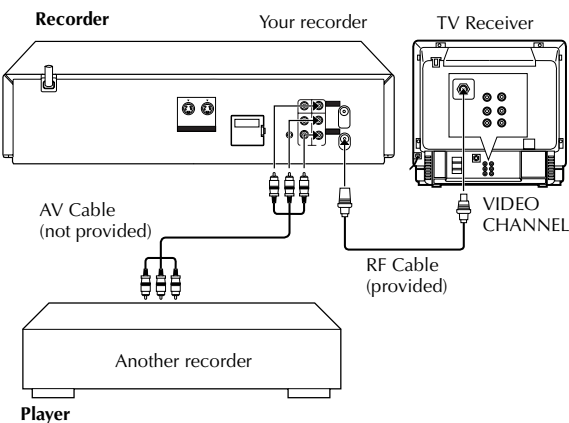
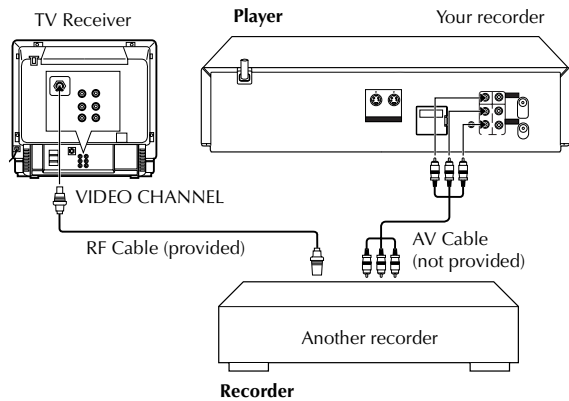

Audio Dubbing

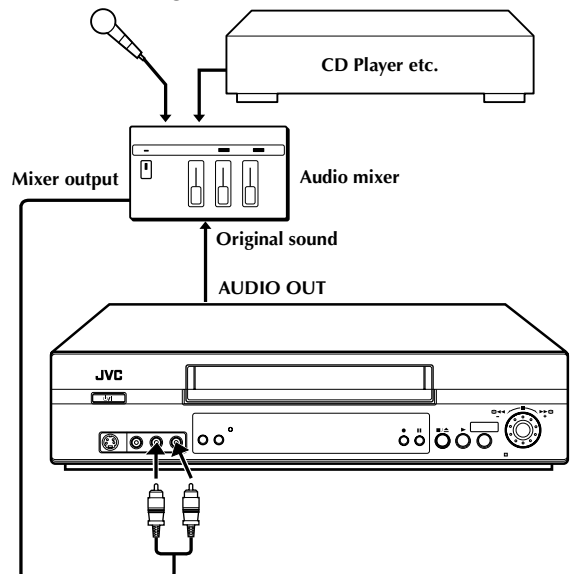

Audio dubbing replaces the normal audio sound of a previously recorded tape with a new soundtrack.

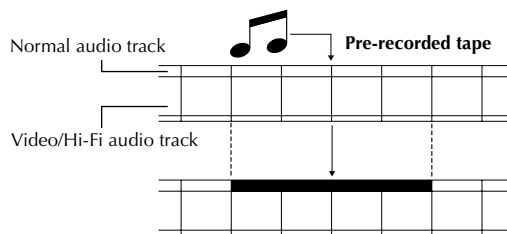

1 Make connections

Connect an audio component to the AUDIO L + R connectors on the recorder's front panel.

- When connecting monaural equipment, use only the recorder's AUDIO L connector.

2 Set input mode

Press number key "0" and/or PR +/- so that "F-1" appears in place of a channel number.

3 Locate input mode

Press ► to start playback of the tape in your recorder, and press II when you find the point where you want to start dubbing.

4 Engage audio dubbing

Press A.DUB.

- Your recorder enters the Audio Dubbing Pause mode. ("0" blinks, "▶" and "II" light up on the front display panel.)
- To perform audio dubbing with audio mixing, press AUDIO on the remote control to select "L+R" at this point.

* Audio dubbing with audio mixing is not possible if you're using a monaural audio component, or if you don't have an audio mixer

5 Start dubbing

Engage the audio component's Play mode, then press ► to start the tape in your recorder. Audio dubbing begins at this point.

- "0" blinks and "▶" is displayed on the front display panel.
- To stop dubbing temporarily, press II. Press ► to resume dubbing.

6 End audio dubbing

Press ■ to stop the tape in your recorder, and engage the audio component's Stop mode.

NOTES:

- When monitoring the sound during Audio Dubbing, the normal soundtrack is automatically selected. If you wish to hear the mixed sound (Hi-Fi + Normal soundtracks), press AUDIO on the remote control to select "NORM" (HI FI + NORM) (ⓘ 8).
- Audio dubbing stops automatically when the counter reaches "0:00:00", and the recorder enters the Play mode. Check the counter reading before dubbing.
- Audio dubbing is also possible using the rear panel AUDIO IN L + R connectors. When using these connectors, make sure to select the correct input mode in step 2.
- Audio dubbing cannot be performed on a cassette that has had its record safety tab removed.
- When playing back an audio-dubbed tape, press AUDIO on the remote control to select the soundtrack you wish to hear (ⓘ 8).

System Connections

Connecting/Using a Stereo System

These instructions enable you to connect your video recorder to your Hi-Fi stereo system (if you have one) and listen to the soundtrack through the stereo.

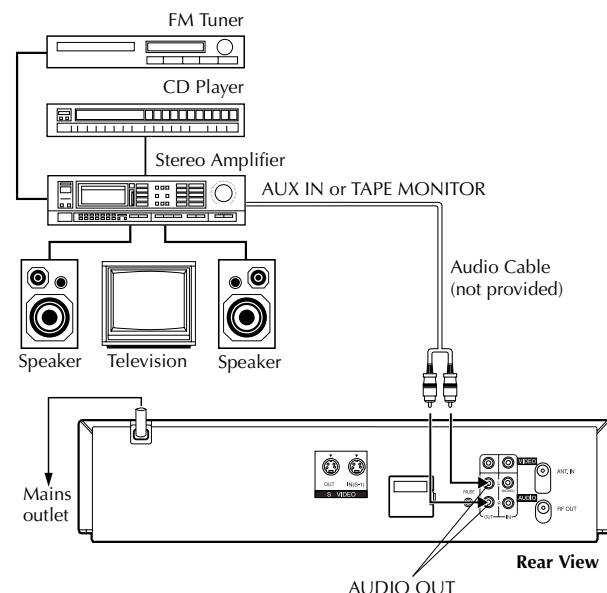

Make Connections

Connect the AUDIO OUT L and R connectors on your video recorder to the AUX IN or TAPE MONITOR terminals on your stereo system's receiver or amplifier.

NOTES:

- When connecting your recorder's audio output connectors to a stereo amplifier, make sure you connect L and R correctly.
- If stereo or bilingual TV broadcasts are receivable in your area, this recorder can record them independently of the TV set and play them back through the connected stereo system.
- When listening to sound through the connected stereo system, turn the TV's volume down completely.

CAUTIONS

- This recorder has a dynamic range of more than 80 dB with regards to its Hi-Fi audio capability. It is recommended that you check the maximum level if you are going to listen to the Hi-Fi audio signals through a stereo amplifier. A sudden surge in the input level to the speakers may damage them.
- Some speakers and televisions are specially shielded to prevent television interference. If both are of the non-shielded type, do not place the speakers adjacent to the TV set as this can adversely affect the video playback picture.

Specifications

GENERAL

Power requirement	
Rating	: AC 110 V – 240 V~, 50 Hz/60 Hz
Operating	: AC 90 V – 260 V~, 50 Hz/60 Hz
Power consumption	: 20 W
Temperature	
Operating	: 5°C to 40°C
Storage	: –20°C to 60°C
Operating position	: Horizontal only
Dimensions (W x H x D)	: 400 mm x 94 mm x 278 mm
Weight	: 3.4 kg
Format	: S-VHS/VHS standard
Maximum recording time	
(SP)	: 240 min. with E-240 video cassette (PAL/MESECAM)
	: 160 min. with T-160 video cassette (NTSC)
(LP)	: 480 min. with E-240 video cassette (PAL/MESECAM)
(EP)	: 720 min. with E-240 video cassette (PAL/MESECAM)
	: 480 min. with T-160 video cassette (NTSC)

VIDEO/AUDIO

Signal system	: PAL-type colour signal and CCIR monochrome signal, 625 lines/50 fields
	: NTSC colour and EIA monochrome signals, 525 lines/60 fields
Recording system	: DA-4 (Double Azimuth) head helical scan system
Signal-to-noise ratio	: 45 dB
Horizontal resolution	
S-VHS	: 400 lines
VHS PAL/MESECAM	: 250 lines
VHS NTSC	: 220 lines
Frequency range	
Normal audio	: 70 Hz to 10,000 Hz
Hi-Fi audio	: 20 Hz to 20,000 Hz
Input/Output	: RCA connectors: IN x 2, OUT x 1 S-Video connectors: IN x 2, OUT x 1

TUNER/TIMER

TV channel storage capacity	: 99 positions (+AUX position)
Tuning system	: Frequency synthesized tuner
Channel coverage	
VHF	: (Low) 42 MHz – 175 MHz/ (High) 175 MHz – 470 MHz
UHF	: 470 MHz – 870 MHz
Aerial output	: UHF channels (Adjustable E28 – E60)
Memory backup time	: Approx. 6 months Estimated figure based on supplied fresh battery; actual performance may differ.

ACCESSORIES

Provided accessories	: RF cable, S-Video cable, Infrared remote control unit, “R6/UM-3” battery x 2, Lithium battery – CR2025 –
----------------------	------------------------------------------------------------------------------------------------------------------------

Specifications shown are for SP mode unless otherwise specified. Design and specifications subject to change without notice.

Information on Multi-System Compatibility

Off-Air Recording

The built-in multi-system tuner is capable of receiving PAL B/G, I and D/K, and SECAM B/G and D/K and NTSC broadcasts.

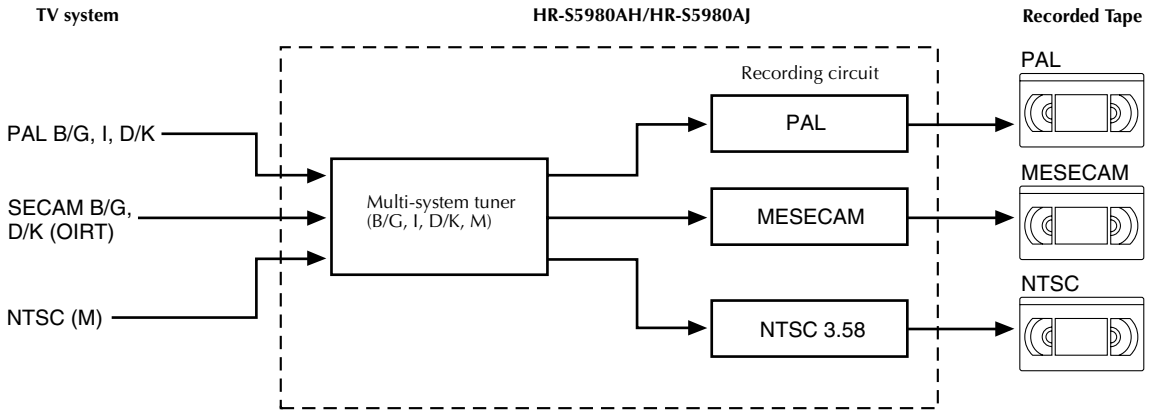

NOTE:

This model does not operate in BRAZIL (PAL-M) or ARGENTINA (PAL-N).

Playback

The recorder can play back all 3 types of recorded tape.

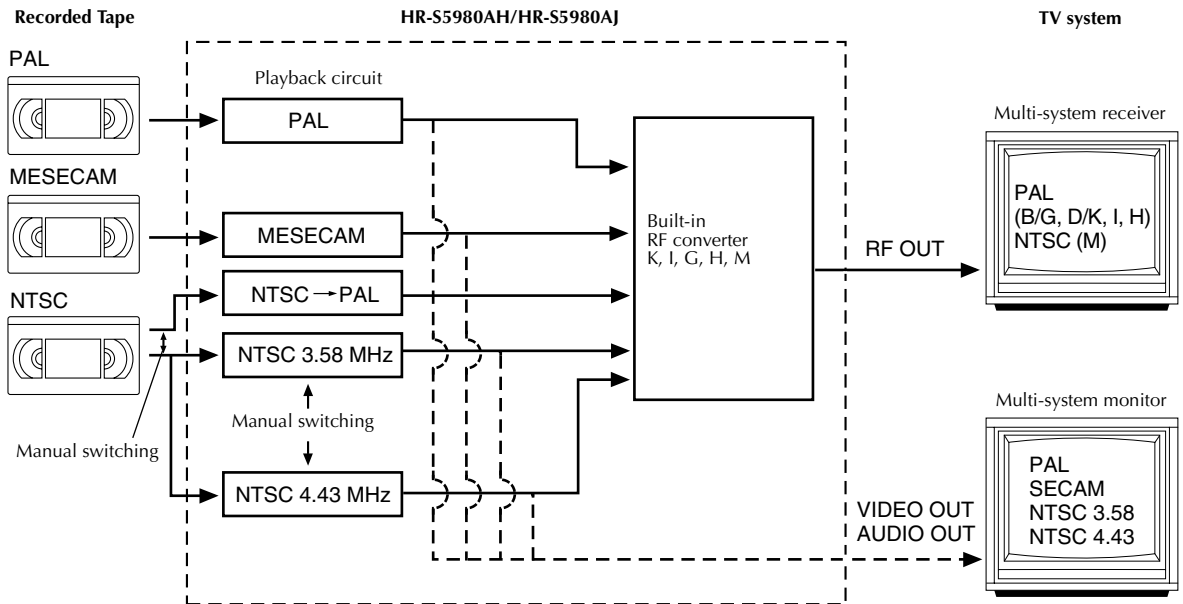

NOTE:

When viewing NTSC tapes on a PAL TV set:

- The picture may shrink vertically with black bars appearing at the top and bottom of the screen. This is not a malfunction on the part of the video recorder nor the TV.
- The picture may roll up or down. This can be corrected using the V-HOLD control found on some TVs. (This cannot be corrected if the TV does not have a V-HOLD control.)
- During search, still, or frame-by-frame playback, the picture will be distorted, and there may be a loss of colour.

ATTENTION

When this recorder is connected to a multi-system TV, the audio signal may not be heard or may be noisy if the colour system select switch of the TV is adjusted to the AUTO position. In such a case, set the TV's colour system select switch to the appropriate position which corresponds to the TV system you have selected at the TV System Select screen.

Tape-To-Tape Editing

There are 4 different types of recorded tape, depending on the signal recorded.

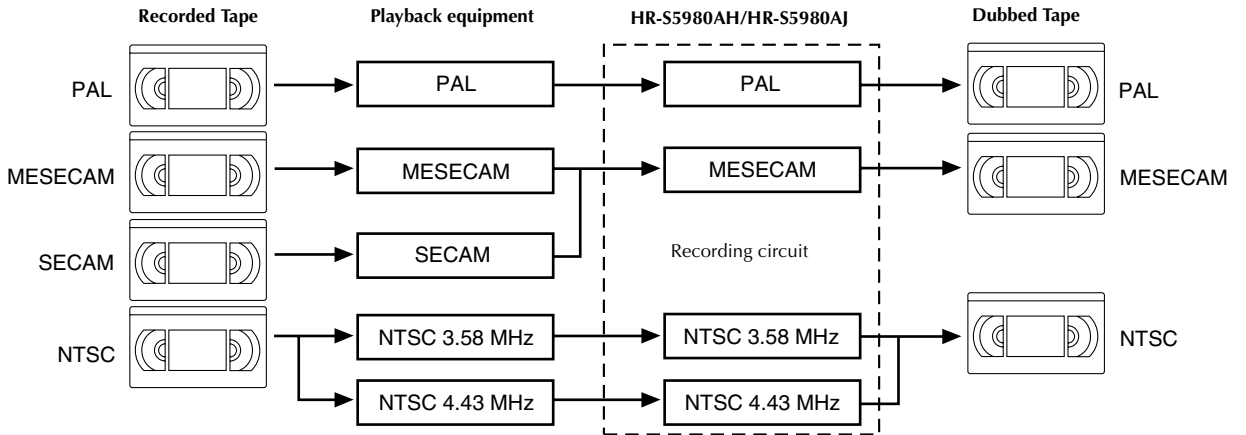

Troubleshooting

Before requesting service for a problem, use this chart and see if you can repair the trouble yourself. Small problems are often easily corrected, and this can save you the trouble of sending your video recorder off for repair.

Power

SYMPTOM	POSSIBLE CAUSE	CORRECTIVE ACTION
No power is applied to the recorder.	<ul style="list-style-type: none"> The mains power cord is disconnected. 	<ul style="list-style-type: none"> Connect the mains power cord.
The clock is functioning properly, but the recorder cannot be powered.	<ul style="list-style-type: none"> "⊖" is displayed on the display panel with Auto Timer set to "OFF". 	<ul style="list-style-type: none"> Press the ⊖ button to turn the "⊖" indicator off.
The remote control won't function.	<ul style="list-style-type: none"> The batteries are discharged. Timer is on. Remote control A/B code is wrong. 	<ul style="list-style-type: none"> Replace the dead batteries with new ones. Press ⊖ on the remote control. Reset A/B code. (☞ 16)

Tape Transport

SYMPTOM	POSSIBLE CAUSE	CORRECTIVE ACTION
The tape does not run during recording.	<ul style="list-style-type: none"> "⏏" is displayed on the display panel. 	<ul style="list-style-type: none"> Press ▶ to turn the "⏏" indicator off.
The tape will not rewind or fast-forward.	<ul style="list-style-type: none"> The tape is already fully rewound or fast-forwarded. 	<ul style="list-style-type: none"> Check the cassette.

Playback

SYMPTOM	POSSIBLE CAUSE	CORRECTIVE ACTION
The playback picture does not appear while the tape is running.	<ul style="list-style-type: none"> If you're using the RF OUT connection the TV receiver's channel selector is not set to the VIDEO channel. . . . the recorder's VIDEO channel has not been correctly set. If you're using the AV or S-VIDEO connection, the TV receiver is not set to the AV mode. 	<ul style="list-style-type: none"> If you are using the RF OUT connection set the TV receiver to the VIDEO channel. (☞ 5) . . . Perform "Video Channel Set". (☞ 5) If you are using the AV or S-VIDEO connection, set the TV to its AV mode.
Noise appears during visual search.	<ul style="list-style-type: none"> This is normal. 	
Noise appears during normal playback.	<ul style="list-style-type: none"> The automatic tracking mode is engaged. 	<ul style="list-style-type: none"> Try manual tracking. (☞ 7)
Noise appears during slow-motion playback.	<ul style="list-style-type: none"> The automatic tracking mode is engaged. 	<ul style="list-style-type: none"> Try manual tracking. (☞ 7)
Noise appears during still playback.		<ul style="list-style-type: none"> Press PR +/- few times to remove the noise bars from the screen.
Breaks are noticeable in Hi-Fi soundtrack.	<ul style="list-style-type: none"> Automatic tracking is engaged. 	<ul style="list-style-type: none"> Engage and adjust tracking manually. (☞ 7)
The playback picture is blurred or interrupted while TV broadcasts are clear. Or "USE CLEANING CASSETTE" appears on the screen.	<ul style="list-style-type: none"> The video heads may be dirty. 	<ul style="list-style-type: none"> The heads must be cleaned. Use a dry cleaning cassette –TCL-2– or consult your JVC dealer.
Playback picture has a loss of colour.	<ul style="list-style-type: none"> The wrong colour system is selected for the tape being played back. The wrong colour system was selected during recording. 	<ul style="list-style-type: none"> Select the correct colour system. (☞ 15) Once recorded, the signal cannot be corrected. Be sure to choose the correct setting before recording.
No sound accompanies the playback picture.	<ul style="list-style-type: none"> The TV system you have selected at the TV System Select screen is incorrect. 	<ul style="list-style-type: none"> Set it to the correct position for the TV broadcast system used in your area. (☞ 17)

Recording

SYMPTOM	POSSIBLE CAUSE	CORRECTIVE ACTION
Recording cannot be started.	<ul style="list-style-type: none"> There is no cassette loaded, or the cassette loaded has had its Record Safety tab removed. 	<ul style="list-style-type: none"> Insert a cassette, or using adhesive tape, reseal the slot where the tab was removed.
TV broadcasts cannot be recorded.	<ul style="list-style-type: none"> "L-1", "F-1", "S-1" or "S-2" has been selected as the input mode. 	<ul style="list-style-type: none"> Set to the desired channel.
Tape-to-tape editing is not possible.	<ul style="list-style-type: none"> The source (another video recorder, camcorder) has not been properly connected. All necessary power switches have not been turned on. The input mode is not correct. 	<ul style="list-style-type: none"> Confirm that the source is properly connected. Confirm that all units' power switches are turned on. Set the input mode to "L-1", "F-1", "S-1" or "S-2".
Camcorder recording is not possible.	<ul style="list-style-type: none"> The camcorder has not been properly connected. The input mode is not correct. 	<ul style="list-style-type: none"> Confirm that the camcorder is properly connected. Set the input mode to "L-1", "F-1", "S-1" or "S-2".

Timer Recording

SYMPTOM	POSSIBLE CAUSE	CORRECTIVE ACTION
Timer recording won't work.	<ul style="list-style-type: none"> The clock and/or the timer have been set incorrectly. The timer is not engaged. 	<ul style="list-style-type: none"> Re-perform the clock and/or timer settings. Press \ominus and confirm that "\ominus" is displayed on the display panel.
On-screen timer programming is not possible.	<ul style="list-style-type: none"> Timer recording is in progress. 	<ul style="list-style-type: none"> Timer programming can't be performed while a timer recording is in progress. Wait until it finishes.
" \ominus " and " \square " on the display panel won't stop blinking.	<ul style="list-style-type: none"> The timer is engaged but there's no cassette loaded. The loaded cassette has had its Record Safety tab removed. 	<ul style="list-style-type: none"> Load a cassette with the Record Safety tab intact, or cover the hole using adhesive tape. Remove the cassette and cover the hole with adhesive tape, or insert a cassette with the Record Safety tab intact.
" \ominus " blinks for 10 seconds and the Timer mode is disengaged.	<ul style="list-style-type: none"> \ominus has been pressed when there are no programs in memory, or the timer record information has been programmed incorrectly. 	<ul style="list-style-type: none"> Check the programmed data and re-program as necessary, then press \ominus again.
The power shuts off and " \ominus " and " \square " won't stop blinking.	<ul style="list-style-type: none"> The end of the tape was reached during timer recording. 	<ul style="list-style-type: none"> The programme may not have been recorded in its entirety. Next time make sure you have enough time on the tape to record the entire programme.
The G-CODE/SHOWVIEW system does not timer-record properly.	<ul style="list-style-type: none"> The recorder's channel positions have been set incorrectly. 	<ul style="list-style-type: none"> Refer to "G-CODE™/SHOWVIEW™ System Setup" and re-perform the procedure. (☞ 10)

Other Problems

SYMPTOM	POSSIBLE CAUSE	CORRECTIVE ACTION
Whistling or howling is heard from the TV during camcorder recording.	<ul style="list-style-type: none"> The camcorder's microphone is too close to the TV. The TV's volume is too high. 	<ul style="list-style-type: none"> Position the camcorder so its microphone is away from the TV. Turn the TV's volume down.
When scanning channels, some of them are skipped over.	<ul style="list-style-type: none"> Those channels have been designated to be skipped. 	<ul style="list-style-type: none"> If you need the skipped channels, restore them. (☞ 5)
The channel cannot be changed.	<ul style="list-style-type: none"> Recording is in progress. 	<ul style="list-style-type: none"> Press \parallel to pause the recording, change channels, then press \blacktriangleright to resume recording.
Channel settings that were made manually seem to have changed or disappeared.	<ul style="list-style-type: none"> After the manual settings were made, Auto Channel Set was performed. 	<ul style="list-style-type: none"> Perform manual setting again.
No channels are stored in the recorder's memory.	<ul style="list-style-type: none"> The TV aerial cable was not connected to the recorder when Auto Set Up was performed. 	<ul style="list-style-type: none"> Connect the TV aerial cable to the recorder properly and turn off the recorder power once, then turn the recorder power back on again. The recorder will try Auto Set Up again. (☞ 5)
"- :- -" is displayed on the front display panel after a power outage.	<ul style="list-style-type: none"> The lithium battery is exhausted. 	<ul style="list-style-type: none"> Replace the lithium battery with a new one. (☞ 2).

EN

HR-S5980AH/S5980AJ

